

NS-E SERIES

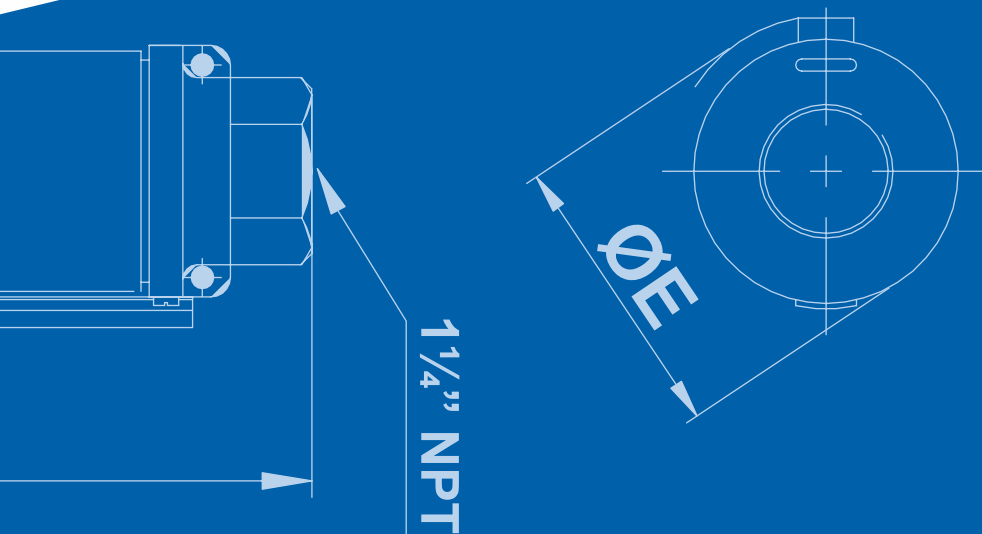

GLASS REINFORCED THERMOPLASTIC SUBMERSIBLE PUMPS

WITH STAINLESS STEEL END BELLS



PRODUCT CATALOGUE

60Hz

www.northam-inc.com

This page is intentionally left blank.

CONTENTS

NS-E GLASS REINFORCED THERMOPLASTIC SUBMERSIBLE PUMPS

General Data	4
Material of Construction	5
Performance Range	6
Model Code	7
Order Information	8
Selection Chart - 5 GPM	9
Selection Chart - 7 GPM	10
Selection Chart - 10 GPM	11
Selection Chart - 13 GPM	12
Selection Chart - 18 GPM	13
Selection Chart - 25 GPM	14
Selection Chart - 33 GPM	15
Selection Chart - 55 GPM	16
Selection Chart - 75 GPM	17
Performance Curve - 5 GPM	18
Performance Curve - 7 GPM	19
Performance Curve - 10 GPM	20
Performance Curve - 13 GPM	21
Performance Curve - 18 GPM	22
Performance Curve - 25 GPM	23
Performance Curve - 33 GPM	24
Performance Curve - 55 GPM	25
Performance Curve - 75 GPM	26
Dimensions - 5 GPM	27
Dimensions - 7 GPM	27
Dimensions - 10 GPM	27
Dimensions - 13 GPM	28
Dimensions - 18 GPM	28
Dimensions - 25 GPM	28
Dimensions - 33 GPM	29
Dimensions - 55 GPM	29
Dimensions - 75 GPM	29

NS-E-N SLIM JIM THERMOPLASTIC SUBMERSIBLE PUMPS

General Data	32
Material of Construction	33
Performance Range	34
Model Code	35
Order Information	36
Selection Chart - 7 GPM	37
Selection Chart - 10 GPM	38
Performance Curve - 7 GPM	39
Performance Curve - 10 GPM	40
Dimensions - 7 GPM	41
Dimensions - 10GPM	41

GLASS REINFORCED THERMOPLASTIC SUBMERSIBLE PUMPS

PUMP SIZE: 4"

GENERAL DATA

5 GPM to 75 GPM

FEATURES

- ▶ Abrasion-resistant construction. Stainless steel bowl casing combined with front wear plate on floating impeller, ensures optimum resistance to abrasion.
- ▶ The suction case & discharge head are made of precision cast stainless steel, ensuring resistance to corrosion, durability and a sturdy coupling to the motor.
- ▶ Stainless steel oversized pump shaft guarantees an effective impeller drive.
- ▶ A stainless steel non-return valve is fitted in the discharge to prevent any back flow of water and alleviate any water hammer to the pump, thus safeguarding impellers & diffusers.
- ▶ These pumps can be coupled to either the 4" or 6" Water Filled rewindable or Encapsulated or Oil Filled submersible motors.
- ▶ Units have left hand threads and are field serviceable with common tools and readily available repair parts.
- ▶ Face clearance and floating impeller stack provides itself as a superior sand handling, durable pump design.
- ▶ Impellers, diffusers and bearing spiders are constructed of corrosion resistant glass reinforced engineering composite material.
- ▶ The proprietary, engineered polymer bearing material is strong and resistant to abrasion & wear. The enclosed intermediate and upper bearing is mounted in a durable glass reinforced thermoplastic bearing spider for excellent abrasion resistance.
- ▶ Easy access to motor mounting nuts using standard open end wrench.
- ▶ Stainless steel casing is strong and corrosion resistant.

APPLICATIONS

- ▶ Residential
- ▶ Irrigation
- ▶ Industrial

OPERATING RANGE & CONDITIONS

	4" Pump
Flow ratings	5, 7, 10, 13, 18, 25, 33, 55 & 75 GPM
Maximum head	1300 feet
Pump ratings	0.5 - 20 hp
Liquid temperature	+32 °F to +113 °F
Max. sand content	50 ppm

GLASS REINFORCED THERMOPLASTIC SUBMERSIBLE PUMPS

PUMP SIZE: 4"

MATERIAL OF CONSTRUCTION

5 GPM to 75 GPM

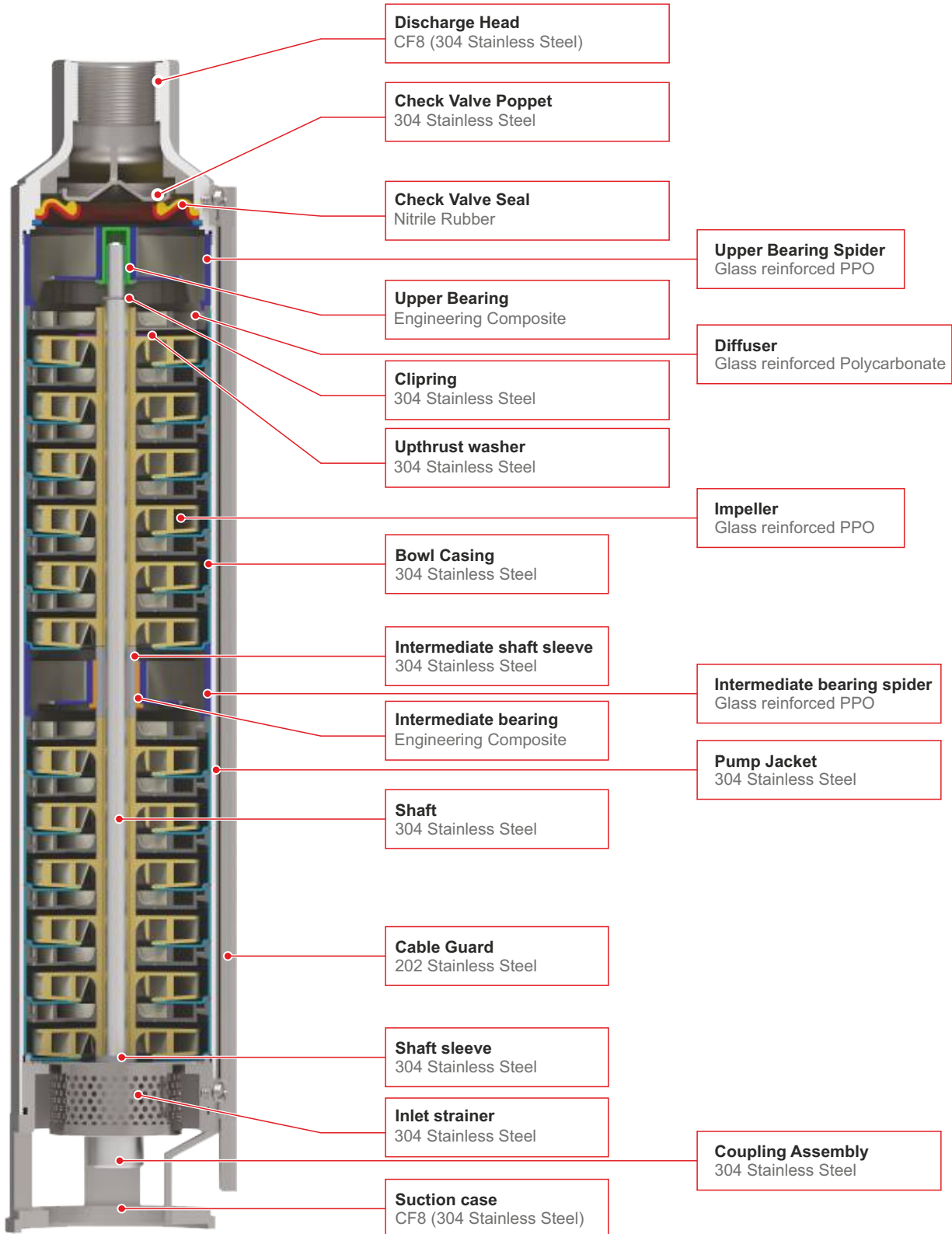

GLASS REINFORCED THERMOPLASTIC SUBMERSIBLE PUMPS

PUMP SIZE: 4"

PERFORMANCE RANGE

5 GPM to 75 GPM

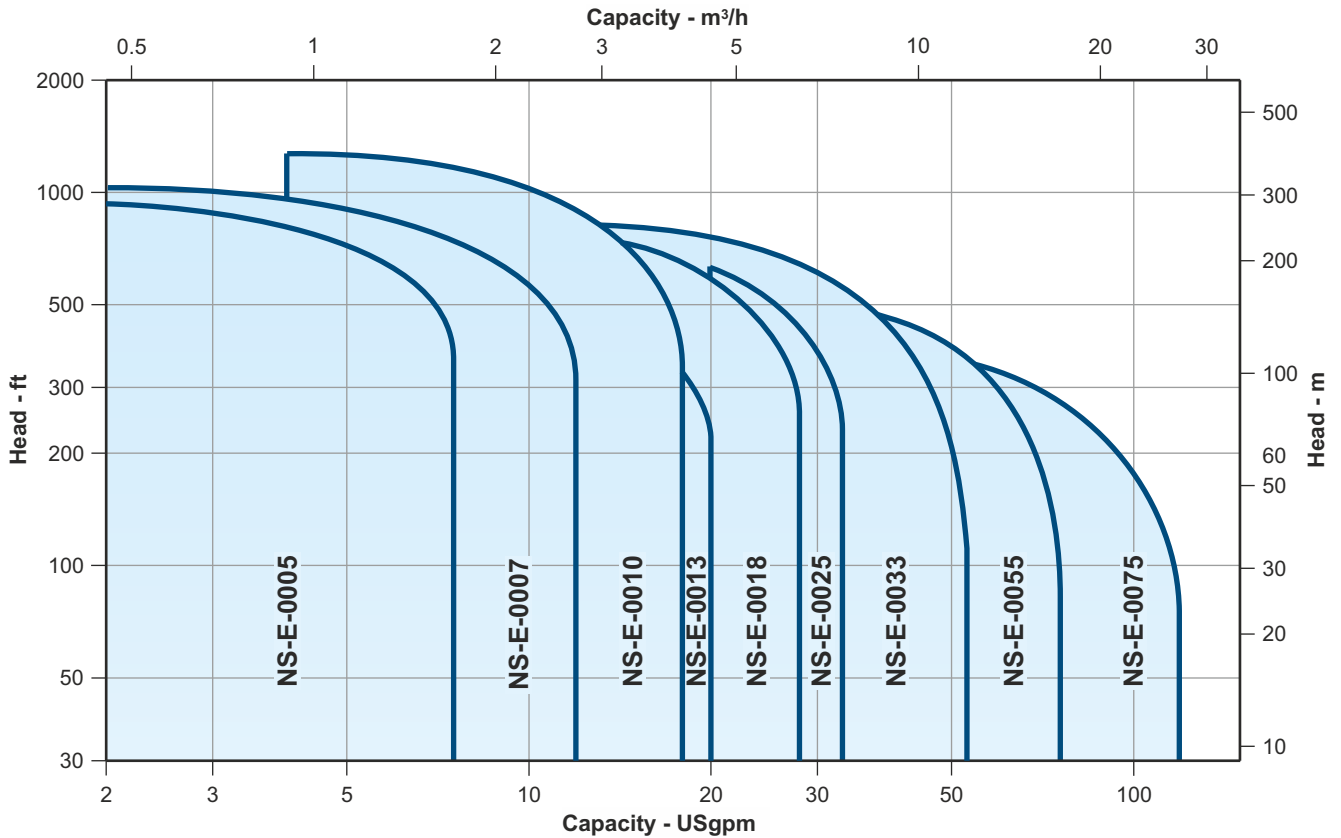

Pump Size	Model Name	Rated Flow
4" PUMP	NS-E-0005	5 GPM
4" PUMP	NS-E-0007	7 GPM
4" PUMP	NS-E-0010	10 GPM
4" PUMP	NS-E-0013	13 GPM
4" PUMP	NS-E-0018	18 GPM
4" PUMP	NS-E-0025	25 GPM
4" PUMP	NS-E-0033	33 GPM
4" PUMP	NS-E-0055	55 GPM
4" PUMP	NS-E-0075	75 GPM

GLASS REINFORCED THERMOPLASTIC SUBMERSIBLE PUMPS

PUMP SIZE: 4" MODEL CODE 5 GPM to 75 GPM

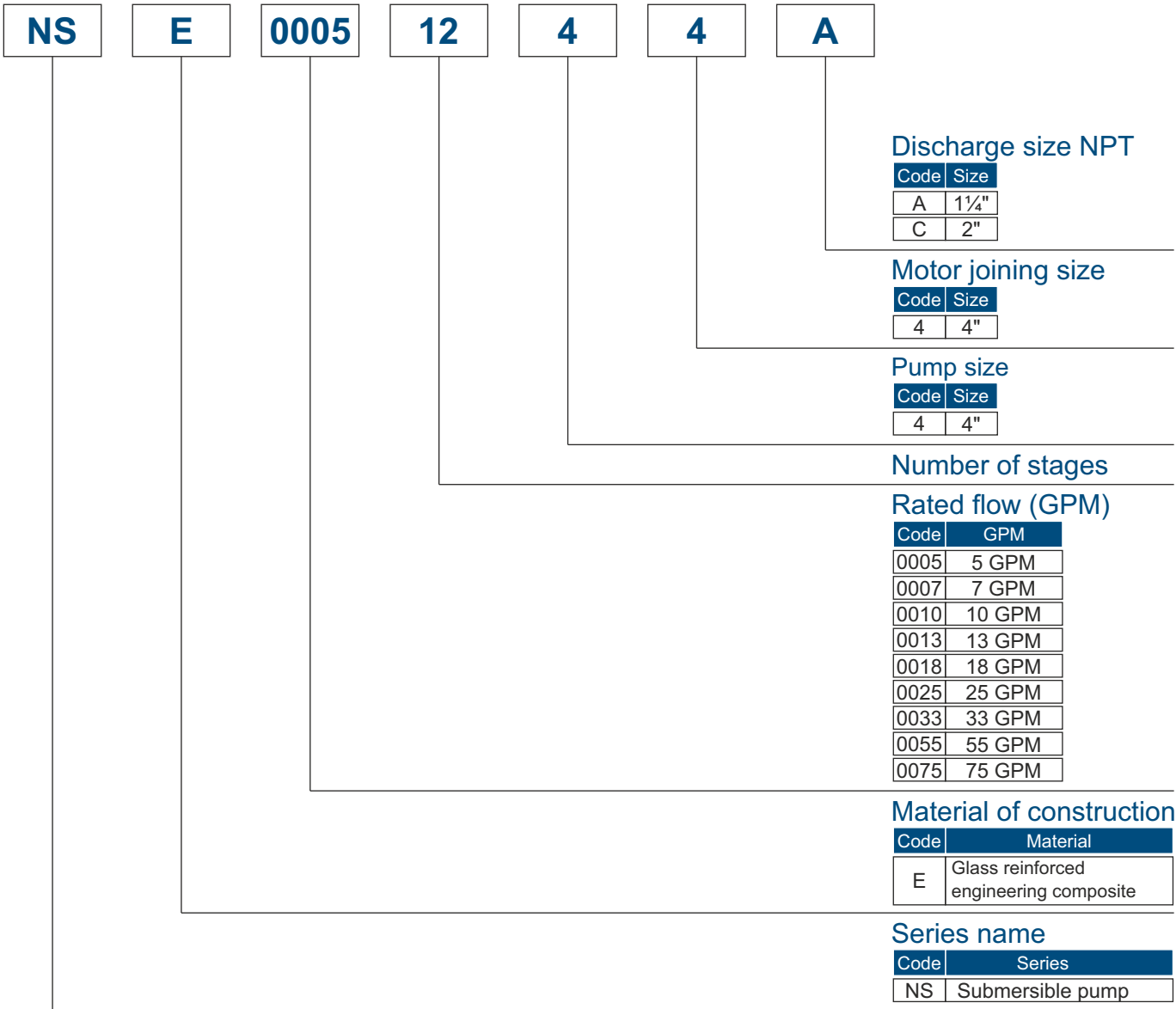

Example:

NS-E-0005-12-4-4-A = Submersible pump, Glass reinforced engineering composite material, 5 GPM, 12 stages, 4" Pump, 4" Motor joining, 1 1/4" Discharge size.

GLASS REINFORCED THERMOPLASTIC SUBMERSIBLE PUMPS

PUMP SIZE: 4"

ORDER INFORMATION

5 GPM to 75 GPM

GPM	STAGES	MOTOR JOINING SIZE	ORDER NO. / MODEL CODE
5	09	4"	NS-E-0005-09-4-4-A
	11	4"	NS-E-0005-11-4-4-A
	15	4"	NS-E-0005-15-4-4-A
	20	4"	NS-E-0005-20-4-4-A
	26	4"	NS-E-0005-26-4-4-A
	31	4"	NS-E-0005-31-4-4-A
7	07	4"	NS-E-0007-07-4-4-A
	10	4"	NS-E-0007-10-4-4-A
	13	4"	NS-E-0007-13-4-4-A
	17	4"	NS-E-0007-17-4-4-A
	22	4"	NS-E-0007-22-4-4-A
	27	4"	NS-E-0007-27-4-4-A
10	34	4"	NS-E-0007-34-4-4-A
	05	4"	NS-E-0010-05-4-4-A
	07	4"	NS-E-0010-07-4-4-A
	10	4"	NS-E-0010-10-4-4-A
	12	4"	NS-E-0010-12-4-4-A
	17	4"	NS-E-0010-17-4-4-A
	20	4"	NS-E-0010-20-4-4-A
13	27	4"	NS-E-0010-27-4-4-A
	35	4"	NS-E-0010-35-4-4-A
	42	4"	NS-E-0010-42-4-4-A
	05	4"	NS-E-0013-05-4-4-A
	07	4"	NS-E-0013-07-4-4-A
	10	4"	NS-E-0013-10-4-4-A
18	12	4"	NS-E-0013-12-4-4-A
	17	4"	NS-E-0013-17-4-4-A
	21	4"	NS-E-0013-21-4-4-A
	06	4"	NS-E-0018-06-4-4-A
	08	4"	NS-E-0018-08-4-4-A
	11	4"	NS-E-0018-11-4-4-A
	14	4"	NS-E-0018-14-4-4-A
25	19	4"	NS-E-0018-19-4-4-A
	24	4"	NS-E-0018-24-4-4-A
	30	4"	NS-E-0018-30-4-4-A
	07	4"	NS-E-0025-07-4-4-A
	09	4"	NS-E-0025-09-4-4-A
25	11	4"	NS-E-0025-11-4-4-A
	15	4"	NS-E-0025-15-4-4-A
	22	4"	NS-E-0025-22-4-4-A
	26	4"	NS-E-0025-26-4-4-A

GPM	STAGES	MOTOR JOINING SIZE	ORDER NO. / MODEL CODE
33	06	4"	NS-E-0033-06-4-4-C
	07	4"	NS-E-0033-07-4-4-C
	10	4"	NS-E-0033-10-4-4-C
	12	4"	NS-E-0033-12-4-4-C
	18	4"	NS-E-0033-18-4-4-C
	22	4"	NS-E-0033-22-4-4-C
	28	4"	NS-E-0033-28-4-4-C
	31	4"	NS-E-0033-31-4-4-C
55	05	4"	NS-E-0055-05-4-4-C
	07	4"	NS-E-0055-07-4-4-C
	09	4"	NS-E-0055-09-4-4-C
	11	4"	NS-E-0055-11-4-4-C
	13	4"	NS-E-0055-13-4-4-C
	15	4"	NS-E-0055-15-4-4-C
	17	4"	NS-E-0055-17-4-4-C
75	19	4"	NS-E-0055-19-4-4-C
	22	4"	NS-E-0055-22-4-4-C
	04	4"	NS-E-0075-04-4-4-C
	06	4"	NS-E-0075-06-4-4-C
	07	4"	NS-E-0075-07-4-4-C
	09	4"	NS-E-0075-09-4-4-C
75	11	4"	NS-E-0075-11-4-4-C
	12	4"	NS-E-0075-12-4-4-C
	14	4"	NS-E-0075-14-4-4-C
	16	4"	NS-E-0075-16-4-4-C

4" GLASS REINFORCED THERMOPLASTIC SUBMERSIBLE PUMPS

MODEL NAME: NS-E-0005

SELECTION CHART

5 GPM

RATINGS ARE IN GALLONS PER MINUTE (GPM)

HP	Stage	PSI	Depth to pumping water level (Lift) in feet																									
			20	40	60	80	100	120	140	160	180	200	220	240	260	280	300	350	400	450	500	600	700	800	900	1000		
1/2	9	0					7.3	6.8	6.4	5.8	5.2	4.5	3.8	2.6														
		20			7.1	6.7	6.2	5.6	5.0	4.3	3.5	2.4																
		30		7.1	6.6	6.1	5.5	5.0	4.2	3.3	2.0																	
		40	7.4	7.0	6.5	6.0	5.4	4.8	4.0	3.2	1.7																	
		50	6.9	6.5	5.9	5.4	4.7	4.0	3.0	1.5																		
		60	6.4	5.8	5.3	4.5	3.8	2.9																				
Shut-off PSI			115	106	98	89	80	72	63	54	46	37	28	20	11													
1/2	11	0					7.3	6.9	6.5	6.1	5.6	5.2	4.6	4.0	3.4													
		20				7.2	6.8	6.4	6.0	5.5	5.0	4.5	3.8	3.0	2.0													
		30		7.4	7.1	6.7	6.3	5.8	5.4	4.9	4.4	3.7	3.0	2.0														
		40	7.4	7.0	6.7	6.2	5.8	5.3	4.8	4.3	3.6	2.7	1.5															
		50	7.3	7.0	6.6	6.2	5.7	5.3	4.8	4.2	3.6	2.5																
		60	6.9	6.5	6.2	5.7	5.2	4.7	4.0	3.5	2.5	1.5																
Shut-off PSI			143	134	125	117	108	99	91	82	73	65	56	47	39	30	21											
3/4	15	0							7.4	7.1	6.9	6.6	6.3	6.0	5.6	4.6	3.5	1.8										
		20					7.3	7.1	6.8	6.5	6.2	5.9	5.5	5.1	4.7	3.6	2.0											
		30				7.3	7.0	6.7	6.4	6.1	5.8	5.4	5.0	4.6	4.3	3.0												
		40				7.2	7.0	6.7	6.4	6.1	5.8	5.4	5.0	4.6	4.2	3.7	2.2											
		50		7.5	7.2	7.0	6.7	6.3	6.1	5.7	5.3	4.9	4.5	4.1	3.6	3.2												
		60	7.4	7.1	6.9	6.6	6.3	6.0	5.6	5.3	4.9	4.3	4.1	3.5	3.0	2.4												
Shut-off PSI			189	181	172	163	155	146	137	129	120	111	103	94	85	77	55	33	12									
1	20	0								7.4	7.2	7.0	6.8	6.6	6.4	5.8	5.2	4.5	3.7									
		20						7.3	7.1	6.9	6.8	6.5	6.3	6.1	5.8	5.2	4.5	3.8	2.8									
		30					7.3	7.1	6.9	6.7	6.5	6.3	6.0	5.8	5.6	4.9	4.2	3.4	2.3									
		40				7.5	7.3	7.1	6.9	6.7	6.5	6.2	6.0	5.8	5.5	5.2	4.6	3.8	3.0	1.5								
		50			7.4	7.2	7.0	6.8	6.6	6.4	6.2	6.0	5.8	5.5	5.2	4.9	4.2	3.5	2.3									
		60		7.4	7.2	7.0	6.8	6.6	6.4	6.2	5.9	5.7	5.4	5.2	4.9	4.7	3.8	3.0	1.7									
Shut-off PSI				246	237	228	220	211	202	194	185	176	168	159	150	142	120	98	77	55								
1 1/2	26	0													7.1	6.7	6.3	5.8	4.7	3.4								
		20													7.3	7.1	6.7	6.3	5.9	5.3	4.1	2.6						
		30												7.4	7.3	7.1	7.0	6.5	6.1	5.6	5.1	3.8	2.0					
		40											7.4	7.3	7.1	7.0	6.8	6.4	5.9	5.4	4.8	3.5						
		50										7.4	7.2	7.0	6.9	6.7	6.6	6.2	5.7	5.1	4.5	3.2						
		60									7.4	7.2	7.0	6.9	6.7	6.6	6.4	5.9	5.4	4.8	4.2							
Shut-off PSI										280	271	263	254	245	237	228	206	185	163	141	98	55						
2	31	0															7.2	6.8	6.1	5.2	4.1	2.7						
		20															7.2	6.8	6.5	5.7	4.7	3.5	1.8					
		30															7.4	7.0	6.7	6.3	5.5	4.5	3.3					
		40															7.2	6.9	6.5	6.1	5.3	4.3	2.9					
		50															7.1	6.7	6.3	5.9	5.1	3.9	2.5					
		60															7.3	6.9	6.5	6.2	5.7	4.8	3.7	1.9				
Shut-off PSI																304	282	260	239	217	174	130	87.0	43.6				

MOST EFFICIENT OPERATING RANGE.
 PERFORMANCES ARE SUBJECT TO PERIODIC CHANGES DUE TO CONTINUOUS IMPROVEMENTS.

4" GLASS REINFORCED THERMOPLASTIC SUBMERSIBLE PUMPS

MODEL NAME: NS-E-0007

SELECTION CHART

7 GPM

RATINGS ARE IN GALLONS PER MINUTE (GPM)

HP	Stage	PSI	Depth to pumping water level (Lift) in feet																									
			20	40	60	80	100	120	140	160	180	200	220	240	260	280	300	350	400	450	500	600	700	800	900	1000		
1/2	7	0				11.3	10.2	9.0	7.8	6.5	5.0	3.5																
		20		11.0	9.8	8.6	7.4	6.0	4.5	2.8																		
		30	11.0	9.7	8.4	7.1	5.8	4.5	2.5																			
		40	9.5	8.3	7.0	5.6	4.2	2.0																				
		50	8.2	6.8	5.5	4.0	2.0																					
		60	6.5	5.2	3.5																							
Shut-off PSI			89	80	71	63	54	45	36	28	19	10																
1/2	10	0					11.8	11.2	10.4	9.6	8.7	7.8	6.9	5.9	5.0	3.8	2.2											
		20			11.6	10.9	10.0	9.3	8.4	7.5	6.6	5.6	4.7	3.3														
		30		11.5	10.8	10.0	9.1	8.3	7.3	6.4	5.5	4.5	3.2															
		40	11.5	10.8	9.8	9.0	8.1	7.2	6.3	5.3	4.3	3.0																
		50	10.5	9.8	8.9	8.0	7.1	6.2	5.3	4.1	2.8																	
		60	9.6	8.8	7.9	7.0	6.0	5.0	4.0	2.5																		
Shut-off PSI			130	121	113	104	95	87	78	69	61	52	43	35	26	17	9											
3/4	13	0						11.6	11.0	10.4	9.8	9.1	8.5	7.8	7.1	6.3	4.4											
		20					11.4	10.8	10.2	9.6	8.9	8.2	7.6	6.8	6.2	5.4	4.6	2.0										
		30			11.9	11.3	10.8	10.1	9.5	8.8	8.2	7.4	6.8	6.0	5.4	4.5	3.5											
		40		11.8	11.2	10.6	10.0	9.4	8.7	8.0	7.4	6.6	5.9	5.2	4.4	3.4	2.0											
		50	11.8	11.2	10.6	10.0	9.3	8.7	8.0	7.3	6.5	5.8	5.0	4.4	3.2	2.0												
		60	11.0	10.5	9.8	9.2	8.5	7.8	7.3	6.5	5.8	5.0	4.0	3.0	2.0													
Shut-off PSI			172	163	154	146	137	128	120	111	102	94	85	76	68	59	50	29										
1	17	0								11.7	11.2	10.8	10.3	9.8	9.3	8.8	7.5	6.2	4.7	2.8								
		20						11.5	11.0	10.6	10.1	9.7	9.2	8.7	8.2	7.6	6.2	4.8	3.0									
		30					11.9	11.4	11.0	10.5	10.0	9.6	9.1	8.6	8.0	7.5	7.0	5.6	4.0	2.0								
		40				11.8	11.3	10.9	10.5	9.8	9.5	9.0	8.5	8.0	7.5	7.0	6.4	5.0	3.2									
		50			11.8	11.3	10.8	10.4	10.0	9.5	8.9	8.5	8.0	7.5	6.9	6.3	5.8	4.0										
		60		11.7	11.3	10.8	10.3	9.8	9.2	8.8	8.4	7.8	7.3	6.7	6.2	5.6	5.0	3.2										
Shut-off PSI			219	210	201	193	184	175	167	158	149	141	132	123	115	106	84	63	41	19								
1 1/2	22	0									11.7	11.4	11.0	10.7	10.3	9.9	9.0	8.0	7.0	5.9	3.9							
		20						11.9	11.6	11.2	10.9	10.6	10.2	9.8	9.5	9.0	8.0	7.0	6.0	5.0	2.8							
		30					11.8	11.5	11.2	10.9	10.5	10.2	9.8	9.4	9.0	8.6	7.6	6.6	5.6	4.6	2.1							
		40				11.8	11.5	11.1	10.8	10.4	10.1	9.8	9.4	9.0	8.5	8.1	7.0	6.1	5.1	4.1								
		50			11.8	11.5	11.0	10.8	10.5	10.0	9.7	9.3	8.9	8.5	8.1	7.7	6.7	5.7	4.7	3.5								
		60		11.8	11.5	11.0	10.8	10.4	10.0	9.7	9.3	8.9	8.4	8.0	7.6	7.2	6.2	5.2	4.2	3.0								
Shut-off PSI				286	277	269	260	251	243	234	225	217	208	199	191	182	160	139	117	95	52							
2	27	0												11.7	11.4	10.7	10.0	9.2	8.5	6.7	5.0	2.7						
		20												11.7	11.4	11.1	10.8	10.1	9.3	8.5	7.7	6.0	4.0					
		30												11.6	11.3	11.0	10.7	10.5	9.7	8.9	8.2	7.3	5.6	3.5				
		40												11.5	11.2	11.0	10.7	10.4	10.0	9.4	8.5	7.7	6.9	5.2	2.9			
		50												11.5	11.3	11.0	10.7	10.4	10.0	9.8	9.0	8.3	7.4	6.5	4.7	2.2		
		60							11.7	11.5	11.2	11.0	10.6	10.3	10.0	9.8	9.5	8.6	7.8	7.0	6.0	4.1						
Shut-off PSI							314	306	297	288	279	271	262	253	245	223	201	180	158	115	71	28						
3	34	0																11.7	11.2	10.6	9.4	8.1	6.8	5.2	3.0			
		20																11.8	11.2	10.7	10.1	8.8	7.5	6.1	4.3			
		30																11.5	11.0	10.4	9.8	8.5	7.2	5.7	3.8			
		40																11.8	11.2	10.7	10.1	9.5	8.3	6.8	5.3	3.2		
		50																11.8	11.5	11.0	10.4	9.8	9.2	7.9	6.5	4.9	2.5	
		60																11.8	11.5	11.3	10.7	10.2	9.5	8.9	7.6	6.2	4.5	
Shut-off PSI																349	340	332	310	288	267	245	202	158	115	72	28	

MOST EFFICIENT OPERATING RANGE.
 PERFORMANCES ARE SUBJECT TO PERIODIC CHANGES DUE TO CONTINUOUS IMPROVEMENTS.

4" GLASS REINFORCED THERMOPLASTIC SUBMERSIBLE PUMPS

MODEL NAME: NS-E-0013

SELECTION CHART

13 GPM

RATINGS ARE IN GALLONS PER MINUTE (GPM)

HP	Stage	PSI	Depth to pumping water level (Lift) in feet																								
			20	40	60	80	100	120	140	160	180	200	220	240	260	280	300	350	400	450	500	600	700	800	900	1000	
1/2	5	0			19.6	17.8	15.5	12.5	7.0																		
		20	19.2	17.0	14.6	11.4	4.0																				
		30	16.8	14.0	10.6																						
		40	13.5	10.0																							
		50	9.0																								
		60																									
Shut-off PSI			55	47	38	29	21	12	3																		
3/4	7	0				20.0	18.6	17.0	15.3	13.4	10.6	6.0															
		20		19.5	18.2	16.5	14.8	12.5	9.6																		
		30	19.3	18.0	16.5	14.5	12.3	9.0																			
		40	17.6	16.0	14.0	12.0	8.2																				
		50	15.8	13.8	11.5	7.8																					
		60	13.5	11.0	6.5																						
Shut-off PSI			81	72	63	55	46	37	29	20	11	3															
1	10	0						19.6	18.8	17.8	16.6	15.4	14.0	12.5	10.5	7.0											
		20				19.4	18.5	17.4	16.3	15.0	13.5	12.0	9.5	5.5													
		30			19.3	18.4	17.3	16.0	14.8	13.2	11.5	9.0	4.0														
		40		19.1	18.1	17.0	15.8	14.5	13.0	11.4	8.5																
		50	19.0	18.0	17.0	15.6	14.4	12.7	11.0	8.0																	
		60	17.8	16.7	15.5	14.0	12.6	10.5	7.3																		
Shut-off PSI			119	110	102	93	84	76	67	58	50	41	32	24	15	6											
1 1/2	12	0								19.0	18.2	17.4	16.5	15.4	14.2	13.0	11.5	4.0									
		20				19.6	18.8	18.0	17.1	16.1	15.0	13.8	12.5	11.0	8.8	4.5											
		30			19.5	18.7	17.9	16.9	16.0	14.8	13.6	12.5	10.6	8.2	4.0												
		40		19.2	18.5	17.7	16.8	15.8	14.6	13.5	12.0	10.5	8.0														
		50	19.3	18.5	17.6	16.6	15.6	14.5	13.3	12.0	10.0	7.0															
		60	19.2	18.4	17.5	16.5	15.5	14.3	13.0	11.5	10.0	6.8															
Shut-off PSI			145	136	127	119	110	101	93	84	75	67	58	49	41	32	23	2									
2	17	0										19.8	19.3	18.7	18.1	17.5	16.8	15.0	12.8	9.8							
		20									19.6	19.1	18.5	17.9	17.3	16.7	15.9	15.1	13.0	10.1							
		30								19.5	19.0	18.5	17.9	17.2	16.5	15.8	15.0	14.2	11.8	8.0							
		40						19.5	18.9	18.4	17.8	17.1	16.5	15.6	14.9	14.0	13.2	10.5	4.2								
		50			19.9	19.3	18.8	18.3	17.7	17.0	16.4	15.6	14.8	13.9	13.0	12.0	8.6										
		60		19.8	19.3	18.8	18.2	17.6	16.9	16.2	15.5	14.6	13.8	12.8	11.9	10.6	5.0										
Shut-off PSI				191	183	174	165	157	148	139	131	122	113	105	96	87	66	44	22								
3	21	0												19.5	19.1	18.6	17.4	16.0	14.4	12.5	5.5						
		20												19.0	18.5	18.0	17.5	16.1	14.5	12.7	10.5						
		30										19.7	19.3	18.9	18.5	17.9	17.5	16.9	15.5	13.7	11.8	8.8					
		40									19.7	19.2	18.8	18.4	17.8	17.4	16.8	16.2	14.6	12.9	10.6	6.7					
		50							19.6	19.2	18.7	18.3	17.8	17.3	16.7	16.1	15.5	13.8	11.9	9.1	3.0						
		60						19.5	19.1	18.7	18.2	17.7	17.2	16.6	16.0	15.5	14.8	13.0	10.9	7.0							
Shut-off PSI							216	208	199	190	182	173	164	156	147	138	117	95	73	52	8						

MOST EFFICIENT OPERATING RANGE.
 PERFORMANCES ARE SUBJECT TO PERIODIC CHANGES DUE TO CONTINUOUS IMPROVEMENTS.

4" GLASS REINFORCED THERMOPLASTIC SUBMERSIBLE PUMPS

MODEL NAME: NS-E-0018

SELECTION CHART

18 GPM

RATINGS ARE IN GALLONS PER MINUTE (GPM)

HP	Stage	PSI	Depth to pumping water level (Lift) in feet																										
			20	40	60	80	100	120	140	160	180	200	220	240	260	280	300	350	400	450	500	600	700	800	900	1000			
3/4	6	0				26.6	24.0	20.5	16.0	10.0																			
		20		26.0	23.0	19.0	14.5	7.0																					
		30	25.5	22.5	18.5	13.5	5.0																						
		40	22.0	17.5	12.0																								
		50	17.0	12.0																									
		60	10.0																										
Shut-off PSI			66	57	49	40	31	23	14	5																			
1	8	0					26.8	24.8	22.5	20.0	17.2	14.0	8.0																
		20				24.3	22.0	19.5	16.5	12.5																			
		30		26.0	24.0	22.0	19.0	16.0	12.0																				
		40	25.5	23.5	21.5	19.0	15.5	11.5																					
		50	23.5	21.0	18.0	15.0	10.0																						
		60	20.5	18.0	14.5	10.0																							
Shut-off PSI			93	84	75	67	58	49	41	32	23	15	6																
1 1/2	11	0						27.5	26.5	25.0	23.5	22.0	20.2	18.0	16.0	13.0	9.5												
		20					26.0	25.0	23.2	21.5	19.5	17.5	15.0	12.0	8.0														
		30			27.2	26.0	24.5	23.0	21.5	19.5	17.0	14.6	11.0																
		40		27.0	26.0	24.5	23.0	21.0	19.0	17.0	14.5	11.0																	
		50	26.8	25.5	24.0	23.0	21.0	18.6	16.5	14.0	10.0																		
		60	25.5	24.0	22.0	20.5	18.5	16.0	13.5	10.0																			
Shut-off PSI			131	122	113	105	96	87	79	70	61	53	44	35	27	18	9												
2	14	0							27.3	26.5	25.5	24.4	23.0	21.8	20.2	18.6	14.0												
		20						27.0	26.5	25.0	24.0	22.7	21.5	20.0	18.0	16.5	14.0												
		30					27.0	26.0	25.0	23.7	22.5	21.0	19.8	18.0	16.0	14.0	11.0												
		40			28.0	27.0	26.0	24.7	23.5	22.5	21.0	19.5	17.5	16.0	13.5	10.5													
		50		27.5	26.6	25.8	24.5	23.5	22.2	20.8	19.0	17.5	15.5	13.5	10.0														
		60	27.5	26.8	25.5	24.5	23.2	22.0	20.5	18.8	17.5	15.0	12.5	10.0															
Shut-off PSI			169	160	151	143	134	125	117	108	99	91	82	73	65	56	47	25											
3	19	0										27.5	26.7	26.0	25.5	24.5	22.0	19.5	16.5	12.5									
		20										26.5	26.0	25.0	24.2	23.5	22.4	19.6	16.6	13.0									
		30										27.0	26.5	25.7	25.0	24.2	23.2	22.5	21.5	18.5	15.0	10.0							
		40									27.5	27.0	26.5	25.5	24.0	23.0	22.0	21.0	20.0	17.0	13.5								
		50						27.5	27.0	26.5	25.5	24.5	24.0	23.0	22.0	21.0	20.0	18.8	15.5	11.0									
		60					27.5	26.6	26.0	25.5	24.5	24.0	23.0	22.0	21.0	20.0	18.5	17.4	13.5										
Shut-off PSI						206	197	189	180	171	163	154	145	137	128	119	111	89	67	46	24								
5	24	0												27.7	27.1	26.7	25.0	23.5	21.5	19.5	13.8								
		20												27.5	27.0	26.5	25.8	25.3	23.5	21.8	19.7	17.0	10.0						
		30												27.5	27.0	26.5	25.8	25.0	24.5	22.8	20.7	18.5	15.8	7.5					
		40												27.4	27.0	26.4	25.8	25.0	24.5	23.7	22.0	19.8	17.3	14.3					
		50												28.0	27.5	26.9	26.4	25.5	25.0	24.5	23.5	23.0	21.0	18.5	16.0	12.8			
		60												28.0	27.5	26.8	26.0	25.5	25.0	24.4	23.5	23.0	22.0	20.0	17.5	14.8	10.8		
Shut-off PSI																													
5	30	0																	27.8	26.5	25.4	24.0	22.9	19.8	15.8	11.0			
		20																	27.5	27.2	26.6	25.5	24.2	23.0	21.5	18.0	13.8	7.9	
		30																	27.5	27.0	26.5	26.0	25.0	23.6	22.2	20.7	17.2	12.5	
		40																	27.0	26.5	26.0	25.5	24.3	23.0	21.6	20.1	16.1	11.5	
		50																	27.0	26.5	26.0	25.5	25.0	23.7	22.5	21.0	19.1	15.1	10.0
		60																	26.8	26.5	26.0	25.5	25.0	24.5	23.0	21.6	20.2	18.4	14.0
Shut-off PSI																													
Shut-off PSI																													
Shut-off PSI																													

MOST EFFICIENT OPERATING RANGE.
 PERFORMANCES ARE SUBJECT TO PERIODIC CHANGES DUE TO CONTINUOUS IMPROVEMENTS.

4" GLASS REINFORCED THERMOPLASTIC SUBMERSIBLE PUMPS

MODEL NAME: NS-E-0025

SELECTION CHART

25 GPM

RATINGS ARE IN GALLONS PER MINUTE (GPM)

HP	Stage	PSI	Depth to pumping water level (Lift) in feet																										
			20	40	60	80	100	120	140	160	180	200	220	240	260	280	300	350	400	450	500	600	700	800	900	1000			
1	7	0			32.6	30.6	28.5	26.0	23.5	20.4	16.0	11.0																	
		20	32.4	30.0	27.8	25.5	22.5	19.0	14.5	8.5																			
		30	30.0	27.5	25.0	22.0	18.5	14.0	7.0																				
		40	27.0	24.5	21.5	18.0	13.5																						
		50	24.0	21.0	17.5	12.0																							
		60	20.0	16.5	11.5																								
Shut-off PSI			83	74	65	57	48	39	31	22	13	5																	
1½	9	0					32.0	30.2	28.5	26.8	25.0	22.4	20.0	16.0	11.2														
		20			31.5	30.0	28.0	26.0	24.0	21.8	19.0	15.0	10.0																
		30		31.0	29.5	27.6	26.0	24.0	21.0	18.2	14.2	8.0																	
		40	30.8	29.5	27.5	25.5	23.5	21.0	17.5	14.0	6.0																		
		50	29.0	27.2	25.2	23.0	20.5	17.0	13.0																				
		60	27.0	25.0	23.0	20.0	16.5	12.0																					
Shut-off PSI			111	103	94	85	77	68	59	51	42	33	25	16	7														
2	11	0						31.9	30.5	28.8	27.4	25.5	23.5	21.5	20.0	16.0													
		20					31.4	30.0	28.2	26.6	25.0	23.0	21.0	18.2	15.0	10.0													
		30				31.0	29.5	28.0	26.5	24.6	22.9	20.5	18.0	14.8	10.0														
		40			30.8	29.5	28.0	26.4	24.5	22.5	20.5	17.5	14.0	9.0															
		50	32.0	30.6	29.2	27.5	26.0	24.0	22.0	20.0	17.0	13.0	6.0																
		60	30.5	29.0	27.5	25.6	23.7	22.0	19.5	16.2	12.5																		
Shut-off PSI			139	130	122	113	104	96	87	78	70	61	52	44	35	26	18												
3	15	0								32.3	31.2	30.4	29.3	28.0	27.0	25.8	22.0	17.0	7.0										
		20								31.0	30.0	28.7	27.5	26.5	25.4	23.8	22.4	17.5	9.0										
		30						31.8	30.8	29.8	28.7	27.5	26.5	25.2	23.5	22.0	20.0	14.0											
		40				32.5	31.5	30.6	29.5	28.5	27.5	26.2	25.0	23.5	21.5	20.0	17.8	10.0											
		50			32.5	31.5	30.5	29.5	28.3	27.4	26.0	24.6	23.2	21.5	19.7	17.5	15.0												
		60		32.2	31.5	30.5	29.5	28.2	27.0	25.8	24.3	23.0	21.2	19.5	17.0	14.5	10.0												
Shut-off PSI			183	174	165	157	148	139	130	122	113	104	96	87	78	70	48	26	5										
5	22	0												32.2	31.8	31.1	30.5	28.5	26.5	24.5	22.0	14.5							
		20												31.5	31.0	30.1	29.5	28.8	27.0	24.5	22.0	19.0	8.3						
		30												31.5	31.0	30.0	29.5	28.5	28.0	26.0	23.5	20.6	17.2						
		40									32.0	31.5	30.8	30.0	29.2	28.5	28.0	27.0	24.5	22.2	19.0	15.2							
		50						32.5	32.0	31.2	30.6	30.0	29.0	28.5	27.6	27.0	26.0	23.5	21.2	17.5	12.7								
		60					32.3	32.0	31.0	30.5	29.5	29.0	28.0	27.5	26.6	26.0	25.0	22.5	19.4	16.0	10.0								
Shut-off PSI							247	238	230	221	212	204	195	186	178	169	160	139	117	95	74	30							
5	26	0															32.5	31.0	29.3	27.8	26.0	21.5	15.5						
		20															31.6	31.0	29.5	28.0	26.0	24.0	19.0	11.0					
		30															31.5	31.0	30.5	28.5	27.0	25.0	23.0	17.6	8.0				
		40														32.0	31.5	31.0	30.2	29.5	28.0	26.0	24.0	22.0	16.0				
		50										32.5	32.0	31.5	31.0	30.5	29.5	29.0	27.0	25.5	23.0	21.0	14.0						
		60										32.5	32.0	31.5	30.8	30.0	29.5	29.0	28.0	26.5	24.5	22.0	19.5	12.0					
Shut-off PSI										277	269	260	251	243	234	225	217	195	173	152	130	87	43						

MOST EFFICIENT OPERATING RANGE.
 PERFORMANCES ARE SUBJECT TO PERIODIC CHANGES DUE TO CONTINUOUS IMPROVEMENTS.

4" GLASS REINFORCED THERMOPLASTIC SUBMERSIBLE PUMPS

MODEL NAME: NS-E-0033

SELECTION CHART

33 GPM

RATINGS ARE IN GALLONS PER MINUTE (GPM)

HP	Stage	PSI	Depth to pumping water level (Lift) in feet																									
			20	40	60	80	100	120	140	160	180	200	220	240	260	280	300	350	400	450	500	600	700	800	900	1000		
1	6	0	50.0	46.8	43.0	39.0	34.0	27.0	20.0																			
		20	42.0	38.0	32.0	25.0	17.0																					
		30	37.0	31.0	24.0	16.0																						
		40	30.0	23.0	14.0																							
		50	22.0	12.0																								
		60	10.0																									
Shut-off PSI			66	57	48	40	31	22	14																			
1½	7	0	51.0	48.5	45.5	42.5	39.0	34.0	29.0	23.0	14.0																	
		20	44.5	41.5	37.5	33.0	27.0	20.0	11.0																			
		30	40.5	36.5	33.0	26.0	20.0	10.0																				
		40	36.0	31.0	25.0	18.0																						
		50	30.5	24.0	16.0																							
		60	23.0	15.0																								
Shut-off PSI			80	71	62	54	45	36	28	19	10																	
2	10	0	52.0	50.5	48.0	46.0	44.0	41.5	39.0	36.0	33.0	29.0	25.0	20.0	14.0													
		20	48.0	45.5	43.5	41.0	38.5	35.0	31.5	28.0	23.0	18.0	11.0															
		30	45.0	43.0	40.5	37.5	35.0	31.0	27.0	22.0	17.0	10.0																
		40	43.0	40.0	37.0	34.0	31.0	27.0	22.0	16.0	10.0																	
		50	40.0	37.0	34.0	30.0	26.0	21.0	15.0																			
		60	37.0	33.0	30.0	25.0	20.0	15.0																				
Shut-off PSI			117	109	100	91	83	74	65	57	48	39	31	22	13													
3	12	0	52.5	50.7	49.5	47.5	46.0	44.0	42.0	40.0	38.0	35.0	32.0	29.0	25.0	22.0	17.0											
		20	48.5	47.0	45.5	43.5	41.5	39.5	37.0	34.5	31.5	28.0	24.5	20.0	15.0													
		30	47.0	45.0	43.0	41.0	39.0	36.5	34.0	31.0	28.0	24.0	19.0	14.0														
		40	44.5	43.0	41.0	39.0	36.0	33.5	30.0	27.0	23.0	19.0	14.0															
		50	43.0	40.5	38.0	36.0	33.0	30.0	26.5	23.0	18.0	13.0																
		60	40.0	38.0	35.5	32.5	29.5	26.0	22.0	17.0	12.0																	
Shut-off PSI			143	134	125	117	108	99	91	82	73	65	56	47	39	30	21											
5	18	0	52.5	51.5	50.5	49.5	48.5	47.8	46.5	45.5	44.5	43.0	42.0	40.5	39.0	37.5	36.0	31.0	25.0	18.5	10.0							
		20	50.5	49.5	48.5	47.5	46.5	45.5	44.0	43.0	41.5	40.0	39.0	37.0	35.5	33.5	31.5	26.0	19.0	11.0								
		30	49.0	48.5	47.5	46.0	45.0	43.7	42.5	41.5	40.0	38.5	37.0	35.0	33.0	31.0	29.0	23.0	15.0									
		40	48.5	47.0	46.0	45.0	43.5	42.5	41.0	39.5	38.0	36.5	35.0	33.0	31.0	29.0	26.5	19.0										
		50	47.0	46.0	45.0	43.5	42.0	41.0	39.5	38.0	36.5	34.5	32.5	30.5	28.5	26.0	23.5	16.0										
		60	46.0	44.5	43.5	42.0	41.0	39.0	38.0	36.0	34.0	32.0	30.0	28.0	25.5													
Shut-off PSI			222	213	204	196	187	178	170	161	152	144	135	126	118	109	100	79	57	35	14							
5	22	0	53.0	52.0	51.5	50.5	49.5	49.0	48.0	47.0	46.0	45.0	44.0	43.0	42.0	41.0	39.5	36.0	32.5	28.0	23.0							
		20	51.0	50.5	49.5	48.5	47.5	46.5	45.5	44.5	43.5	42.5	41.5	40.5	39.5	37.8	36.5	32.5	28.5	23.5	17.0							
		30	50.0	49.5	48.5	47.5	46.5	45.5	44.5	43.5	42.5	41.5	40.0	39.0	37.5	36.0	35.0	31.0	26.0	20.5	14.0							
		40	49.0	48.0	47.5	46.5	45.0	44.5	43.0	42.0	41.0	40.0	39.0	37.5	36.0	34.5	33.0	29.0	24.0	17.5	10.0							
		50	48.0	47.0	46.0	45.0	44.0	43.0	42.0	41.0	40.0	39.0	37.0	36.0	34.5	33.0	31.0	26.5	21.5	14.5								
		60	47.0	46.0	45.0	44.0	43.0	42.0	41.0	40.0	38.5	37.0	35.5	34.0	32.5	31.0	29.5	24.0	18.5	11.0								
Shut-off PSI			269	260	251	243	234	225	217	208	199	191	182	173	165	156	147	126	104	82	61	17						
7½	28	0	52.5	52.0	51.4	50.8	50.0	49.2	48.5	48.0	47.0	46.5	45.5	45.0	44.0	43.2	41.0	39.0	36.0	33.0	26.0	17.0						
		20	51.6	51.0	50.5	49.5	49.0	48.5	47.5	47.0	46.0	45.5	44.5	44.0	43.0	42.0	41.5	39.0	36.2	33.5	30.0	22.0	11.0					
		30	51.0	50.2	49.5	49.0	48.0	47.5	46.6	45.8	45.5	44.5	43.5	42.8	42.0	41.0	40.2	37.8	35.0	31.8	28.5	20.0						
		40	50.0	49.5	49.0	48.0	47.5	46.5	45.5	45.0	44.5	43.5	42.5	42.0	41.0	40.0	39.0	36.5	33.5	30.5	26.5	17.5						
		50	49.5	48.5	48.0	47.5	46.5	46.0	45.5	44.5	43.5	42.5	42.0	41.0	40.0	39.0	38.0	35.0	32.0	29.0	24.5	15.0						
		60	48.5	48.0	47.0	46.0	45.5	45.0	44.0	43.0	42.0	41.5	41.0	40.0	39.0	38.0	37.0	34.0	30.5	27.0	23.0	12.5						
Shut-off PSI			344	336	327	318	310	301	292	284	275	266	258	249	240	232	223	201	180	158	136	93	49					
7½	31	0		52.5	52.0	51.4	50.8	50.0	49.5	49.0	48.0	47.5	46.5	46.0	45.0	44.0	43.0	41.0	39.0	36.7	31.0	24.0	14.5					
		20		52.5	52.0	51.3	50.7	50.0	49.2	48.6	48.0	47.2	46.4	45.8	45.0	44.0	43.5	41.5	39.0	36.5	34.0	28.0	20.0					
		30	52.5	51.6	51.0	50.5	50.0	49.0	48.5	47.5	47.0	46.5	45.5	44.5	44.0	43.5	42.5	40.5	38.0	35.5	33.0	26.5	17.5					
		40	51.5	51.0	50.5	50.0	49.0	48.0	47.5	47.0	46.2	45.5	44.5	43.6	43.0	42.0	41.5	39.2	37.0	34.5	31.5	24.5	15.0					
		50	51.0	50.5	49.5	49.0	48.5	47.5	47.0	46.0	45.0	44.5	43.5	43.0	42.0	41.0	40.5	38.0	36.0	33.0	30.0	22.8	12.5					
		60	50.0	49.5	49.0	48.5	47.5	46.5	45.8	45.0	44.5	44.0	43.0	42.0	41.0	40.0	39.5	37.0	34.5	31.5	28.5	20.5	10.0					
Shut-off PSI			382	374	365	356	348	339	330	322	313	304	296	287	278	270	261	239	218	196	174	131	88	44.3				

MOST EFFICIENT OPERATING RANGE.
 PERFORMANCES ARE SUBJECT TO PERIODIC CHANGES DUE TO CONTINUOUS IMPROVEMENTS.

4" GLASS REINFORCED THERMOPLASTIC SUBMERSIBLE PUMPS

MODEL NAME: NS-E-0075 **SELECTION CHART** **75 GPM**

RATINGS ARE IN GALLONS PER MINUTE (GPM)

HP	Stage	PSI	Depth to pumping water level (Lift) in feet																									
			20	40	60	80	100	120	140	160	180	200	220	240	260	280	300	350	400	450	500	600	700	800	900	1000		
2	4	0	105.0	85.0	64.0	39.0																						
		20	78.0	57.0	30.0																							
		30	54.0	24.0																								
		40	20.0																									
		50																										
		60																										
Shut-off PSI			44	35	26	18	9																					
3	6	0			104.0	90.0	76.0	62.0	45.0	25.0																		
		20	100.0	86.0	72.0	57.0	40.0																					
		30	85.0	70.0	55.0	36.0																						
		40	68.0	52.0	32.0																							
		50	50.0	30.0																								
		60	26.0																									
Shut-off PSI			69	61	52	43	35	26	17	9																		
3	7	0			109.0	98.0	86.0	75.0	62.0	48.0	32.0																	
		20		95.0	83.0	70.0	58.0	44.0	26.0																			
		30	92.0	81.0	69.0	55.0	40.0	25.0																				
		40	80.0	66.0	54.0	39.0	21.0																					
		50	65.0	50.0	35.0																							
		60	49.0	34.0																								
Shut-off PSI			83	74	66	57	48	40	31	22	14																	
5	9	0			115.0	108.0	99.0	90.0	81.0	71.0	62.0	51.0	39.0	25.0														
		20	113.0	105.0	96.0	87.0	78.0	69.0	59.0	48.0	35.0	21.0																
		30	104.0	95.0	86.0	77.0	67.0	57.5	46.0	34.0																		
		40	93.0	85.0	75.0	66.0	55.0	44.0	30.0																			
		50	83.0	74.0	64.0	54.0	42.0	29.0																				
		60	72.0	62.0	52.0	40.0	26.0																					
Shut-off PSI			109	100	91	83	74	65	57	48	39	31	22	13														
5	11	0			113.0	107.0	99.0	92.5	85.0	78.0	70.0	62.0	54.0	44.0	34.0	22.0												
		20	117.0	111.0	105.0	97.0	90.0	83.0	75.0	68.0	60.0	51.0	40.0	30.0														
		30	110.0	103.0	96.0	89.0	82.0	74.0	66.0	58.0	49.0	39.0	28.0															
		40	102.0	95.0	87.0	81.0	73.0	65.0	57.0	48.0	38.0	26.0																
		50	94.0	87.0	80.0	72.0	64.0	55.0	46.0	36.0	25.0																	
		60	86.0	78.5	70.0	62.0	54.0	45.0	35.0	23.0																		
Shut-off PSI			136	127	118	110	101	92	84	75	66	58	49	40	32													
5	12	0			115.0	109.0	103.5	97.0	90.0	84.0	77.0	69.0	62.0	54.0	45.0	36.0												
		20		113.0	108.0	102.0	95.0	88.0	81.5	75.0	67.0	59.0	52.0	43.0	33.0	22.0												
		30	112.5	107.0	100.0	94.0	87.0	80.0	73.0	66.0	58.0	50.0	42.0	32.0														
		40	106.0	99.0	93.0	86.0	79.0	72.0	65.0	57.0	49.0	40.0	30.0															
		50	98.0	92.0	85.5	78.0	71.0	64.0	56.0	48.0	39.0	28.0																
		60	90.0	84.0	77.0	70.0	63.0	55.0	46.0	38.0	27.0																	
Shut-off PSI			148	140	131	122	114	105	96	88	79	70	62	53	44	36	27											
7½	14	0			113.5	109.0	104.0	98.0	92.0	86.0	80.0	74.5	68.0	61.5	55.0													
		20		116.5	112.0	107.0	102.0	96.0	90.0	85.0	79.0	72.0	66.0	59.0	52.0	45.0	37.0											
		30	116.0	112.0	106.0	101.0	95.0	90.0	83.0	78.0	72.0	65.0	58.0	52.0	44.0	35.0	26.0											
		40	112.5	106.0	100.0	95.0	88.0	82.0	77.0	71.0	64.0	57.0	50.0	43.0	34.5	25.0												
		50	105.0	99.0	93.0	88.0	82.0	76.0	69.0	63.0	56.0	49.0	41.5	33.0														
		60	98.0	92.5	87.0	81.0	75.0	68.0	61.0	55.0	48.0	40.0	31.0															
Shut-off PSI			173	165	156	147	139	130	121	113	104	95	87	78	69	61	52	30										
7½	16	0						112.0	109.0	104.0	99.0	94.0	89.0	84.0	79.0	74.0	68.0	54.0	36.0									
		20			115.0	111.5	107.0	102.0	97.0	92.0	88.0	82.5	77.5	72.0	66.5	60.0	55.0	37.0										
		30		114.5	110.0	106.0	102.0	97.0	92.0	87.0	82.0	77.0	71.0	66.0	60.0	54.0	47.0	28.0										
		40	114.0	110.0	105.0	101.0	96.0	91.0	86.0	81.0	76.0	70.5	65.0	59.0	53.0	46.0	39.0											
		50	109.0	105.0	100.0	95.0	90.0	85.0	80.5	75.0	69.0	64.0	58.0	52.0	45.0	38.0	29.0											
		60	104.0	99.0	94.0	89.0	84.0	80.0	74.0	69.0	63.0	57.0	51.0	44.0	36.0	28.0												
Shut-off PSI			199	190	182	173	164	156	147	138	130	121	112	104	95	86	78	56	34									

MOST EFFICIENT OPERATING RANGE.
 PERFORMANCES ARE SUBJECT TO PERIODIC CHANGES DUE TO CONTINUOUS IMPROVEMENTS.

4" GLASS REINFORCED THERMOPLASTIC SUBMERSIBLE PUMPS

MODEL NAME: NS-E-0005

PERFORMANCE CURVE

5 GPM

Nominal RPM	3450
Curve based on clear water @	68°F

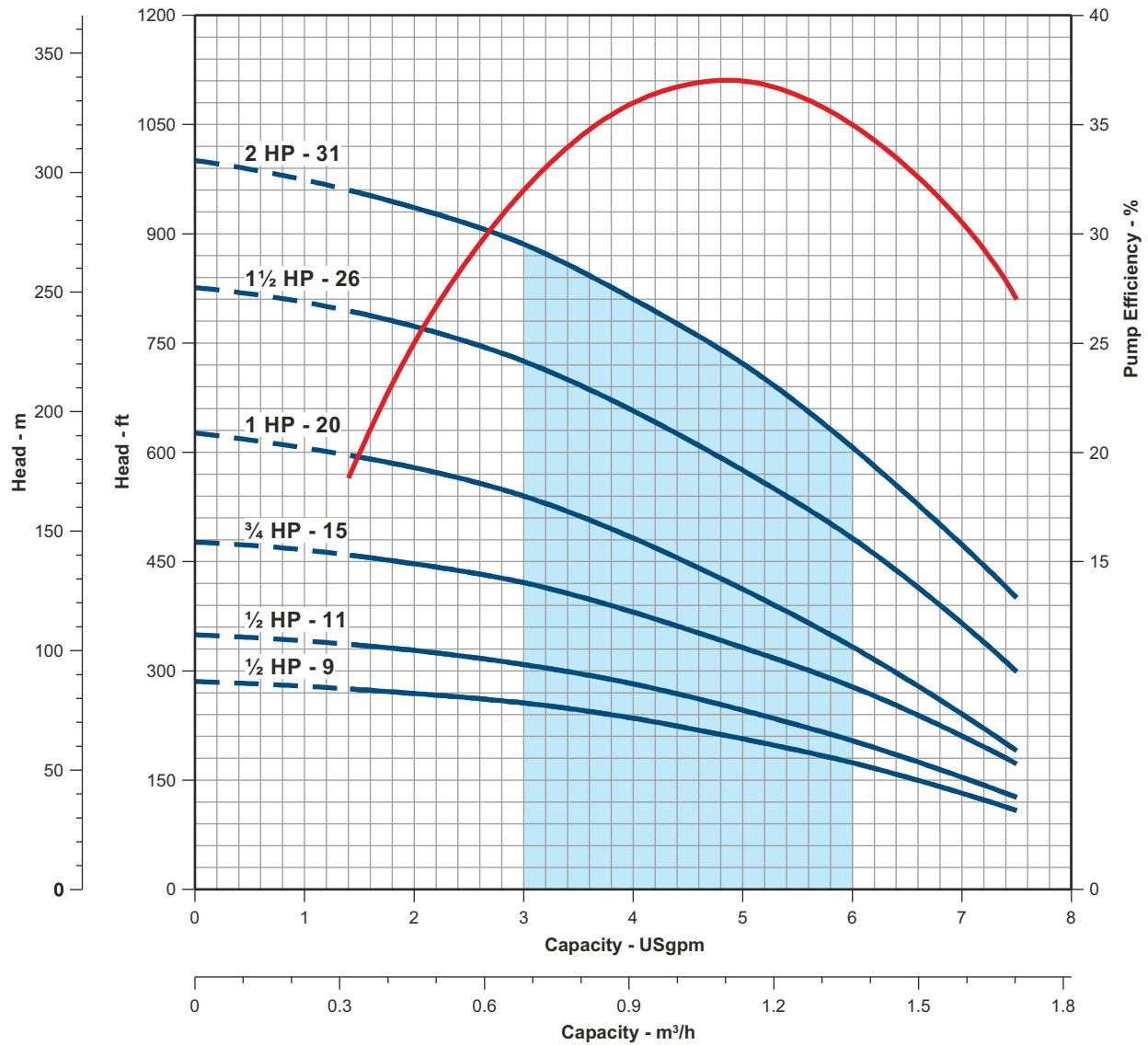

■ BEST EFFICIENCY REGION
— RECOMMENDED PUMP OPERATING RANGE
 PERFORMANCE BASED ON TEST ACCEPTANCE - ISO 9906:2012 3B.
 PERFORMANCES ARE SUBJECT TO PERIODIC CHANGES DUE TO CONTINUOUS IMPROVEMENTS.

4" GLASS REINFORCED THERMOPLASTIC SUBMERSIBLE PUMPS

MODEL NAME: NS-E-0007

PERFORMANCE CURVE

7 GPM

Nominal RPM	3450
Curve based on clear water @	68°F

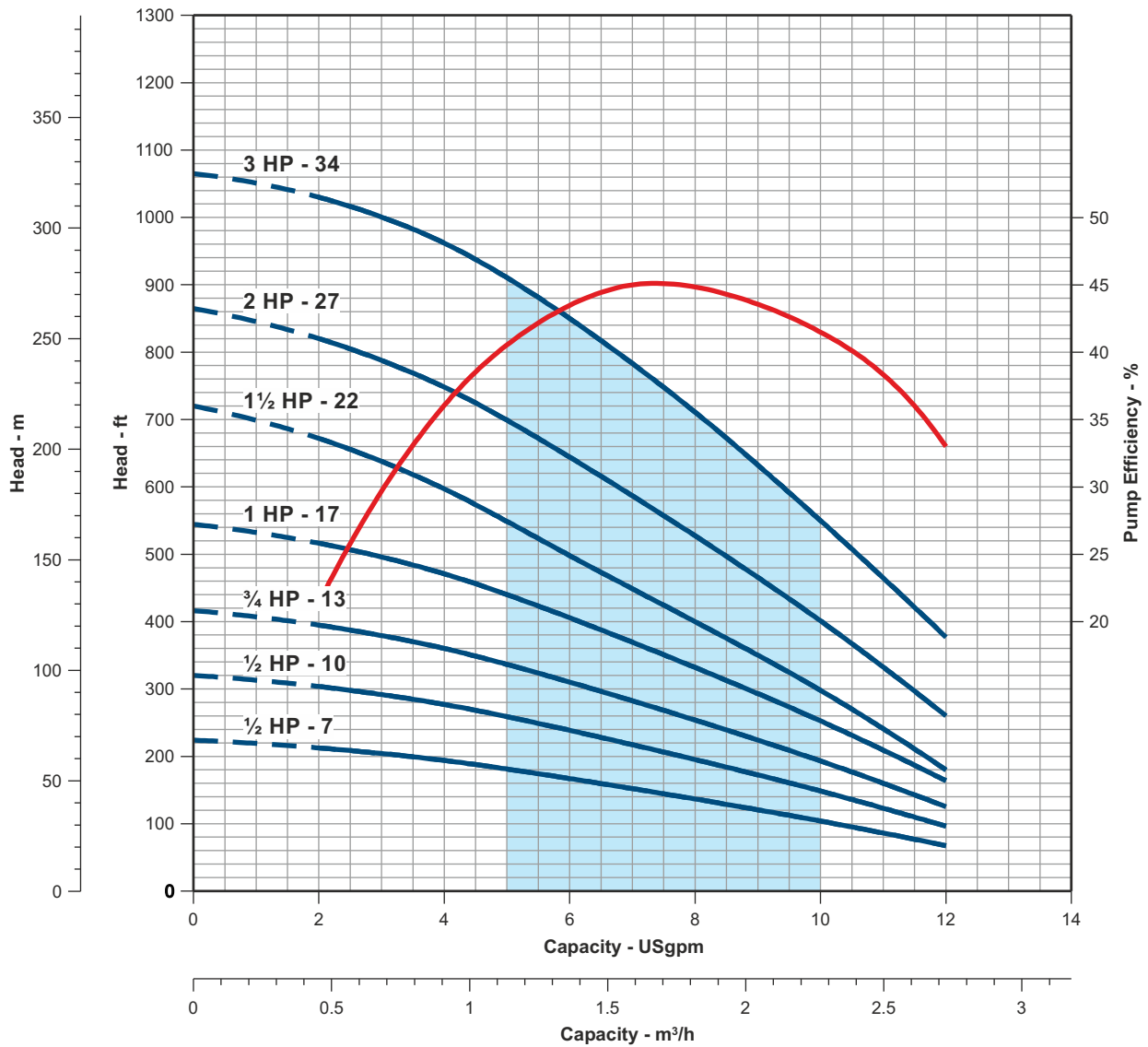

■ BEST EFFICIENCY REGION
— RECOMMENDED PUMP OPERATING RANGE
 PERFORMANCE BASED ON TEST ACCEPTANCE - ISO 9906:2012 3B.
 PERFORMANCES ARE SUBJECT TO PERIODIC CHANGES DUE TO CONTINUOUS IMPROVEMENTS.

4" GLASS REINFORCED THERMOPLASTIC SUBMERSIBLE PUMPS

MODEL NAME: NS-E-0010

PERFORMANCE CURVE

10 GPM

Nominal RPM	3450
Curve based on clear water @	68°F

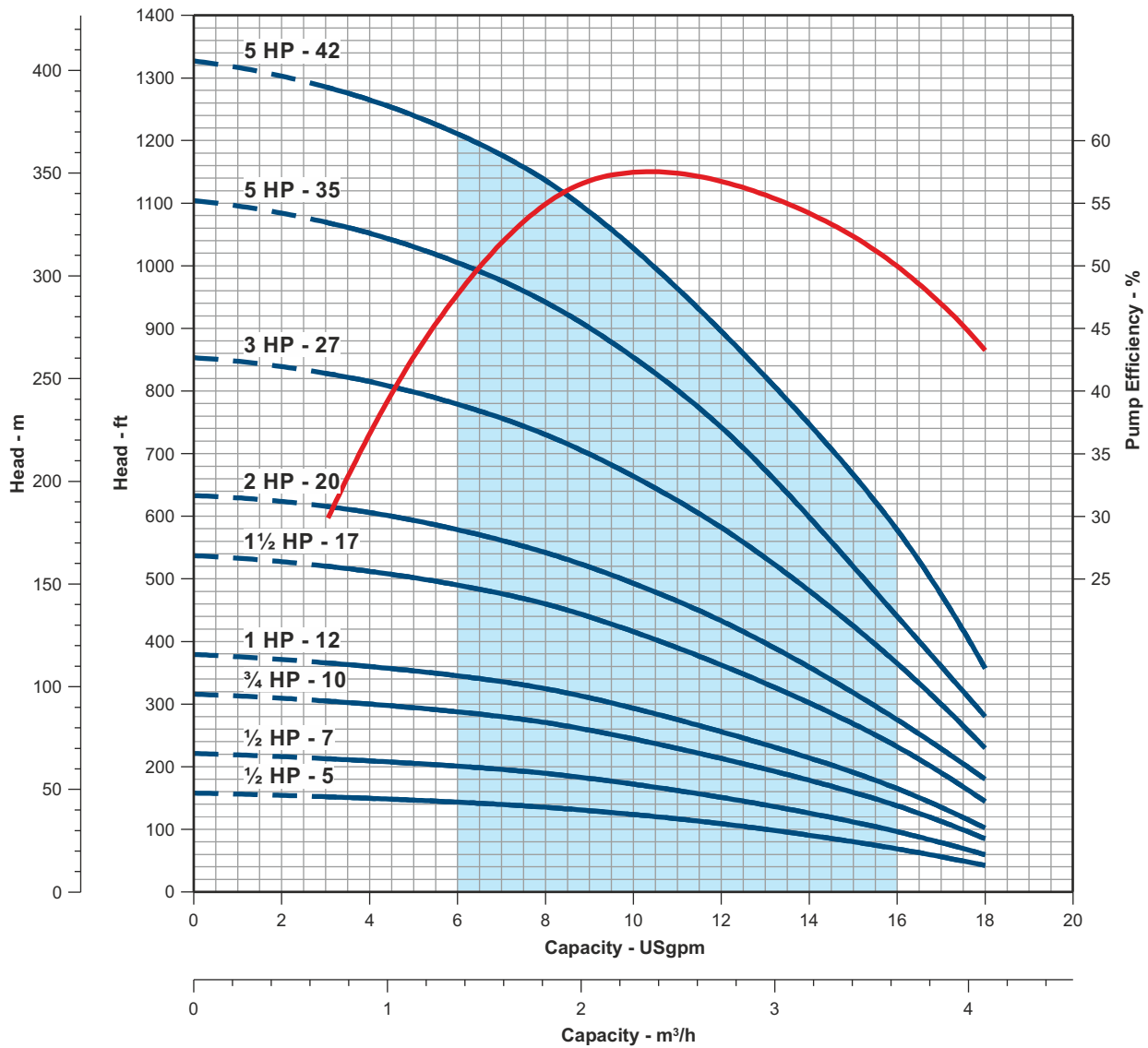

■ BEST EFFICIENCY REGION
— RECOMMENDED PUMP OPERATING RANGE
 PERFORMANCE BASED ON TEST ACCEPTANCE - ISO 9906:2012 3B.
 PERFORMANCES ARE SUBJECT TO PERIODIC CHANGES DUE TO CONTINUOUS IMPROVEMENTS.

4" GLASS REINFORCED THERMOPLASTIC SUBMERSIBLE PUMPS

MODEL NAME: NS-E-0013

PERFORMANCE CURVE

13 GPM

Nominal RPM	3450
Curve based on clear water @	68°F

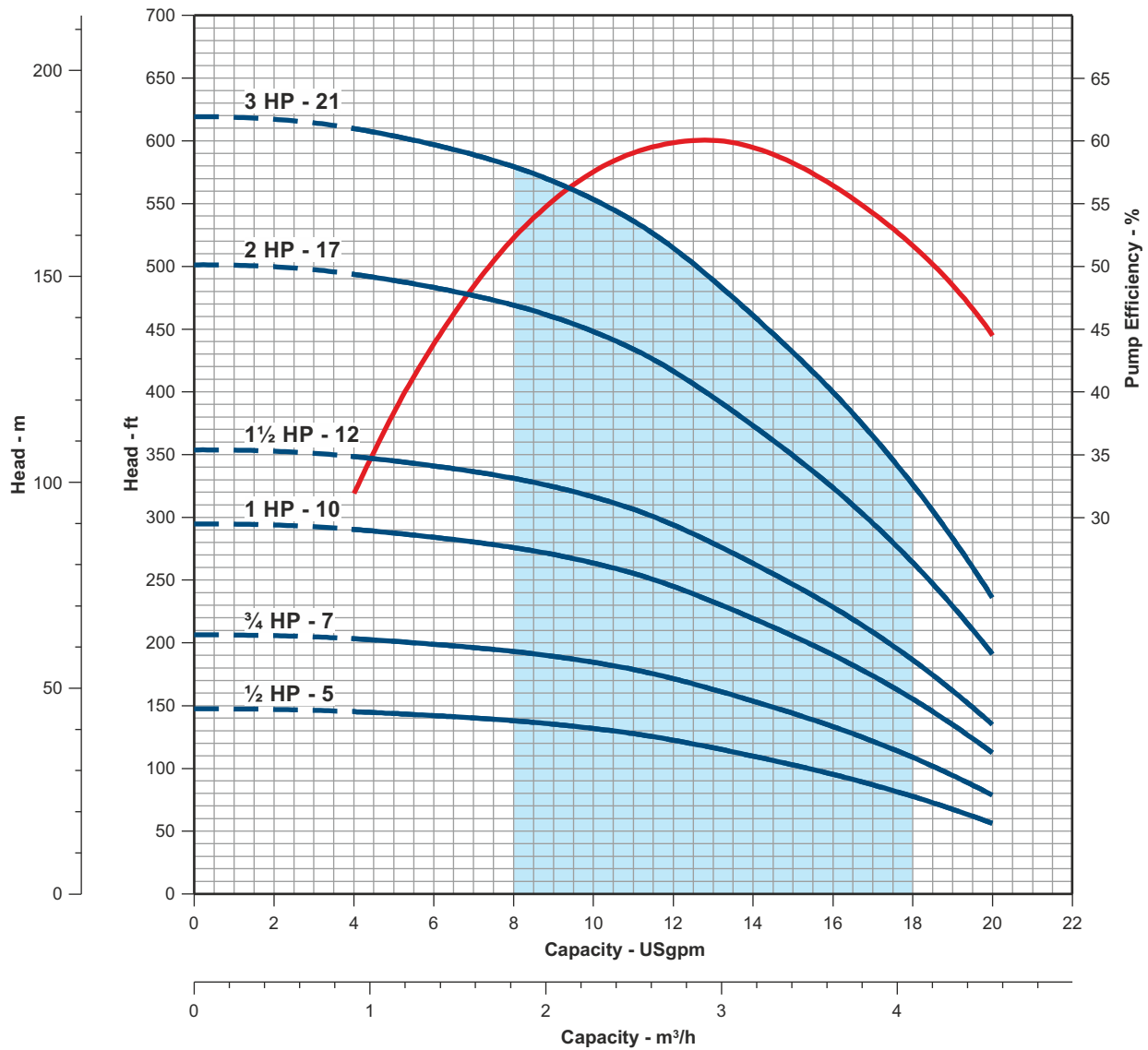

BEST EFFICIENCY REGION
 RECOMMENDED PUMP OPERATING RANGE
 PERFORMANCE BASED ON TEST ACCEPTANCE - ISO 9906:2012 3B.
 PERFORMANCES ARE SUBJECT TO PERIODIC CHANGES DUE TO CONTINUOUS IMPROVEMENTS.

4" GLASS REINFORCED THERMOPLASTIC SUBMERSIBLE PUMPS

MODEL NAME: NS-E-0018

PERFORMANCE CURVE

18 GPM

Nominal RPM	3450
Curve based on clear water @	68°F

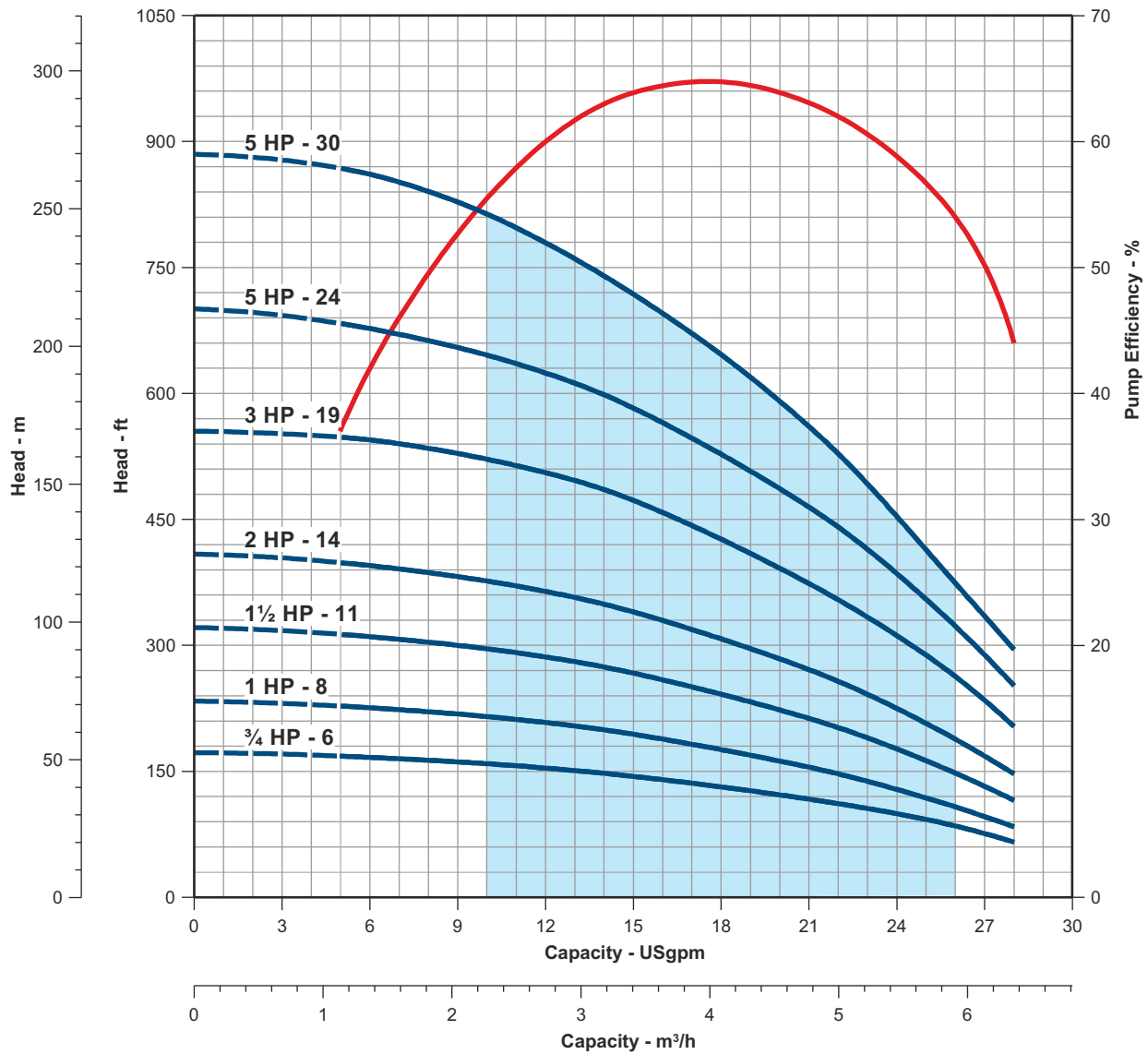

BEST EFFICIENCY REGION
 RECOMMENDED PUMP OPERATING RANGE
 PERFORMANCE BASED ON TEST ACCEPTANCE - ISO 9906:2012 3B.
 PERFORMANCES ARE SUBJECT TO PERIODIC CHANGES DUE TO CONTINUOUS IMPROVEMENTS.

4" GLASS REINFORCED THERMOPLASTIC SUBMERSIBLE PUMPS

MODEL NAME: NS-E-0025

PERFORMANCE CURVE

25 GPM

Nominal RPM	3450
Curve based on clear water @	68°F

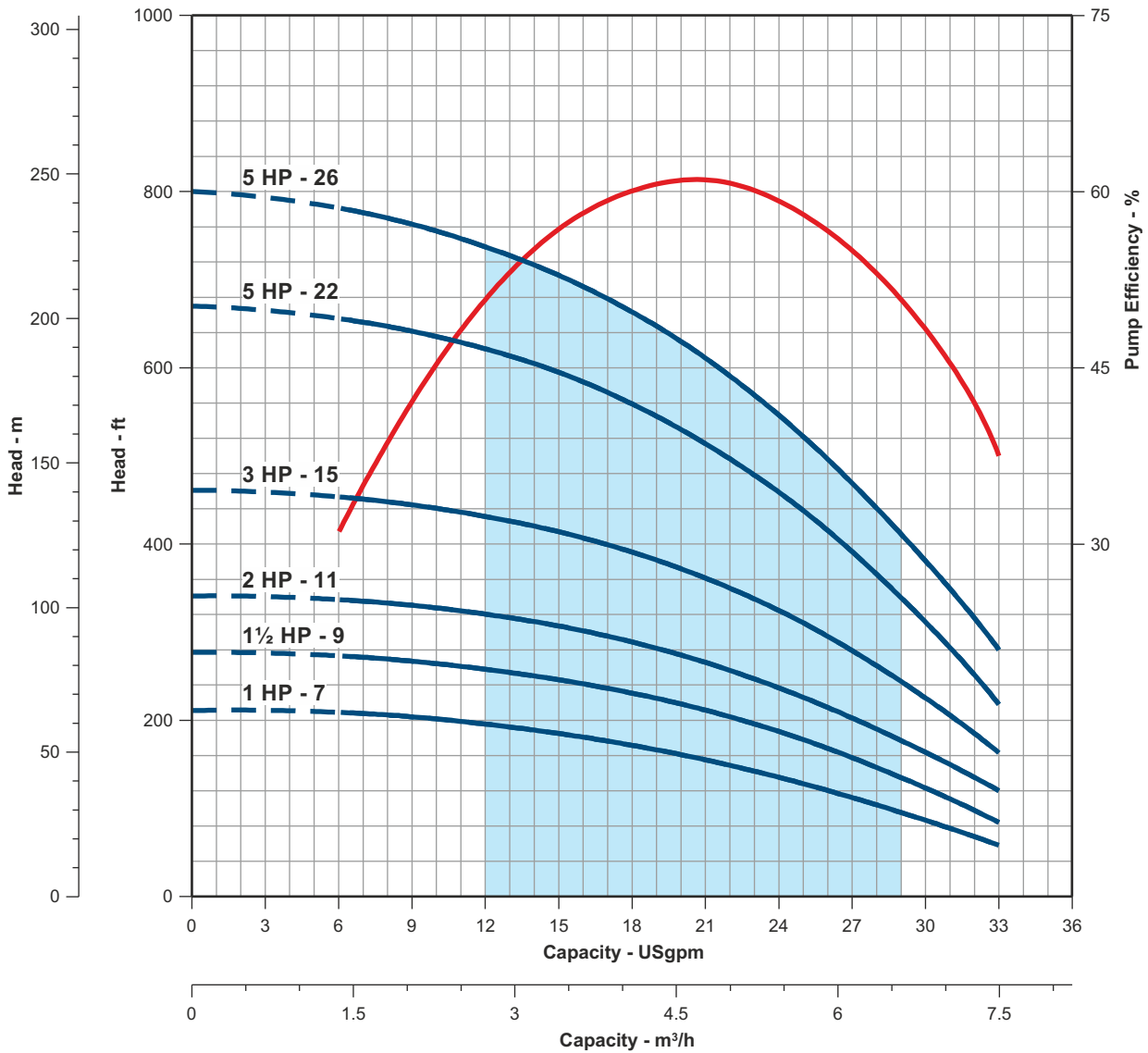

■ BEST EFFICIENCY REGION
— RECOMMENDED PUMP OPERATING RANGE
 PERFORMANCE BASED ON TEST ACCEPTANCE - ISO 9906:2012 3B.
 PERFORMANCES ARE SUBJECT TO PERIODIC CHANGES DUE TO CONTINUOUS IMPROVEMENTS.

4" GLASS REINFORCED THERMOPLASTIC SUBMERSIBLE PUMPS

MODEL NAME: NS-E-0033

PERFORMANCE CURVE

33 GPM

Nominal RPM	3450
Curve based on clear water @	68°F

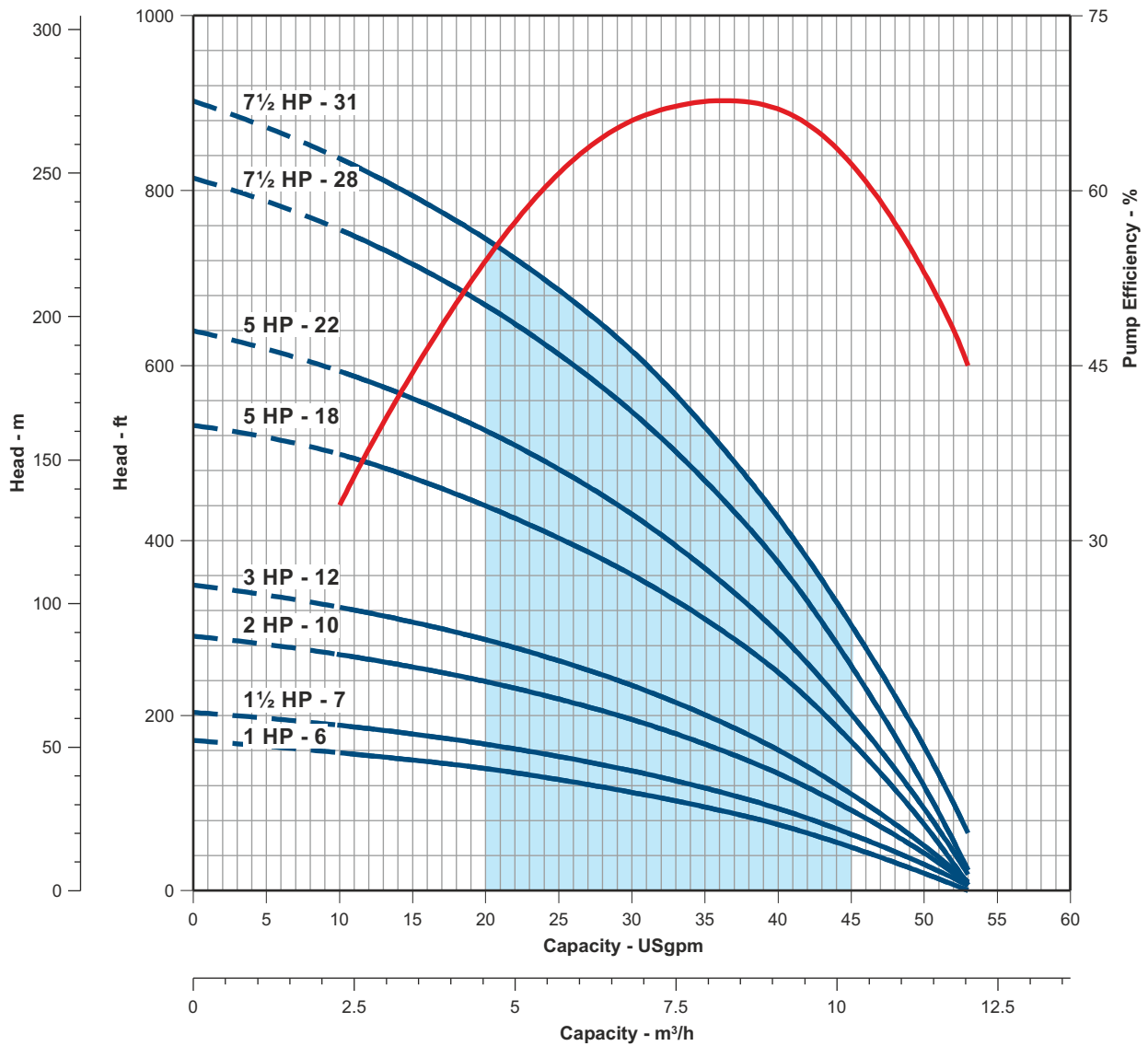

■ BEST EFFICIENCY REGION
— RECOMMENDED PUMP OPERATING RANGE
 PERFORMANCE BASED ON TEST ACCEPTANCE - ISO 9906:2012 3B.
 PERFORMANCES ARE SUBJECT TO PERIODIC CHANGES DUE TO CONTINUOUS IMPROVEMENTS.

4" GLASS REINFORCED THERMOPLASTIC SUBMERSIBLE PUMPS

MODEL NAME: NS-E-0055

PERFORMANCE CURVE

55 GPM

Nominal RPM	3450
Curve based on clear water @	68°F

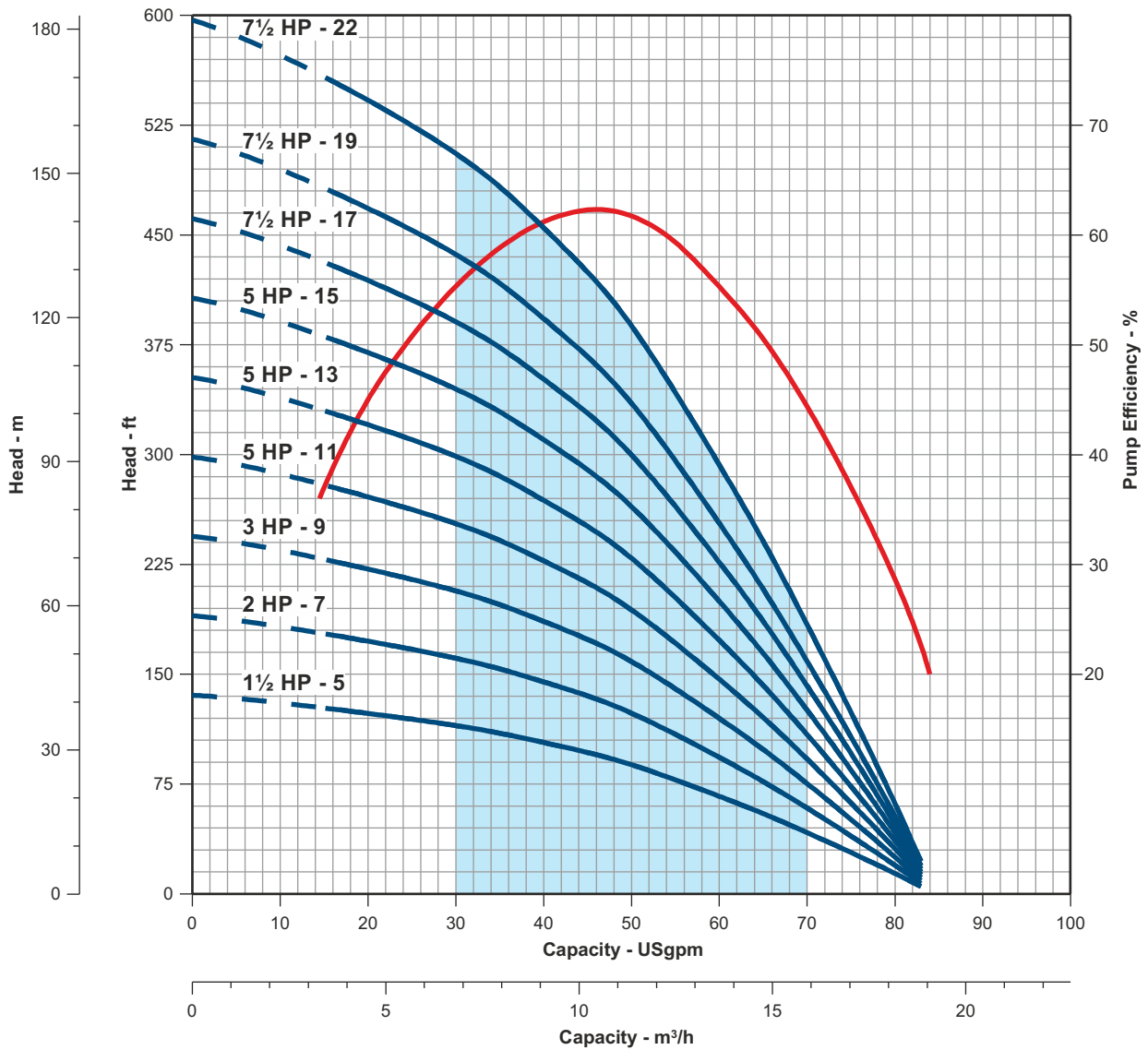

■ BEST EFFICIENCY REGION
■ RECOMMENDED PUMP OPERATING RANGE
 PERFORMANCE BASED ON TEST ACCEPTANCE - ISO 9906:2012 3B.
 PERFORMANCES ARE SUBJECT TO PERIODIC CHANGES DUE TO CONTINUOUS IMPROVEMENTS.

4" GLASS REINFORCED THERMOPLASTIC SUBMERSIBLE PUMPS

MODEL NAME: NS-E-0075

PERFORMANCE CURVE

75 GPM

Nominal RPM	3450
Curve based on clear water @	68°F

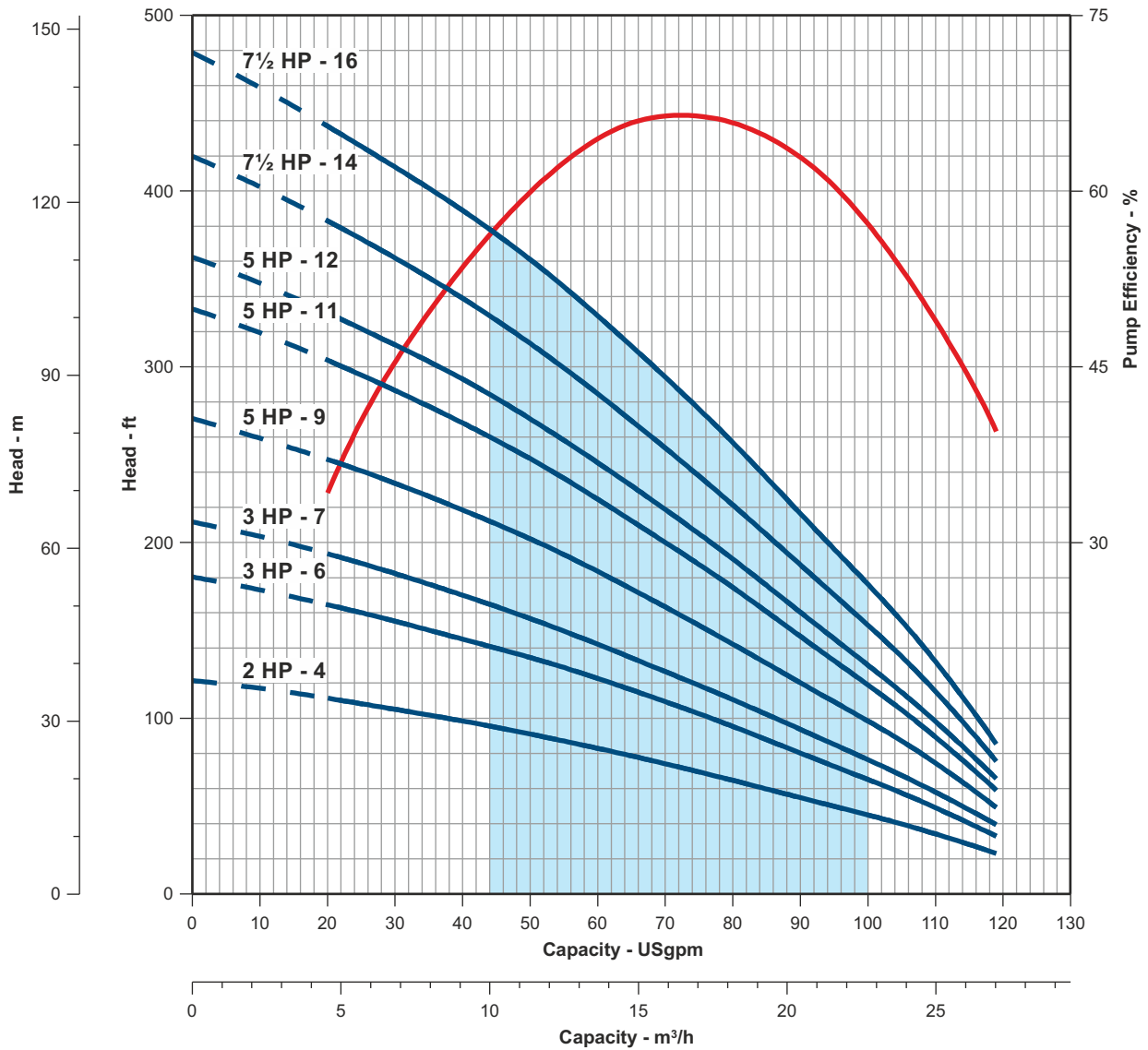

■ BEST EFFICIENCY REGION
— RECOMMENDED PUMP OPERATING RANGE
 PERFORMANCE BASED ON TEST ACCEPTANCE - ISO 9906:2012 3B.
 PERFORMANCES ARE SUBJECT TO PERIODIC CHANGES DUE TO CONTINUOUS IMPROVEMENTS.

GLASS REINFORCED THERMOPLASTIC SUBMERSIBLE PUMPS

PUMP SIZE: 4"

DIMENSIONS

5 GPM to 75 GPM

MODEL NAME: NS-E-0005 PUMP SIZE: 4" 5 GPM

HP	STAGES	MOTOR SIZE [inch]	A [inch]	D [inch] Max. diameter across cable guard	L [inch]	WEIGHT [lbs]
1/2	9	4	1¼ NPT	3.94	13.15	18
1/2	11	4	1¼ NPT	3.94	14.54	19
3/4	15	4	1¼ NPT	3.94	17.28	21
1	20	4	1¼ NPT	3.94	21.93	22
1½	26	4	1¼ NPT	3.94	26.06	28
2	31	4	1¼ NPT	3.94	30.34	30

MODEL NAME: NS-E-0007 PUMP SIZE: 4" 7 GPM

HP	STAGES	MOTOR SIZE [inch]	A [inch]	D [inch] Max. diameter across cable guard	L [inch]	WEIGHT [lbs]
1/2	7	4	1¼ NPT	3.94	11.77	14
1/2	10	4	1¼ NPT	3.94	13.86	15
3/4	13	4	1¼ NPT	3.94	15.91	20
1	17	4	1¼ NPT	3.94	18.66	22
1½	22	4	1¼ NPT	3.94	23.31	24
2	27	4	1¼ NPT	3.94	26.73	28
3	34	4	1¼ NPT	3.94	32.76	32

MODEL NAME: NS-E-0010 PUMP SIZE: 4" 10 GPM

HP	STAGES	MOTOR SIZE [inch]	A [inch]	D [inch] Max. diameter across cable guard	L [inch]	WEIGHT [lbs]
1/2	5	4	1¼ NPT	3.94	10.39	10
1/2	7	4	1¼ NPT	3.94	11.77	11
3/4	10	4	1¼ NPT	3.94	13.86	12
1	12	4	1¼ NPT	3.94	15.24	14
1½	17	4	1¼ NPT	3.94	18.66	20
2	20	4	1¼ NPT	3.94	21.93	23
3	27	4	1¼ NPT	3.94	27.91	28
5	35	4	1¼ NPT	3.94	33.43	33
5	42	4	1¼ NPT	3.94	39.45	39

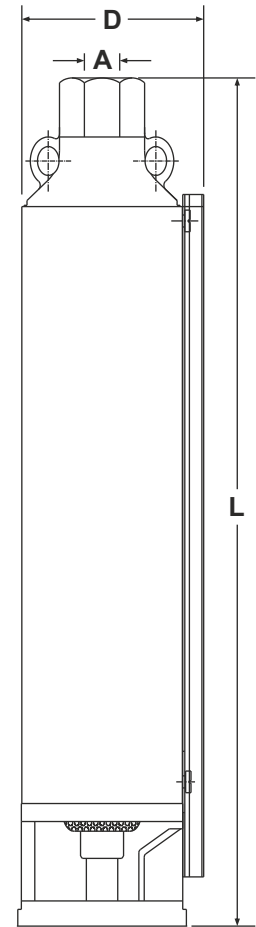

GLASS REINFORCED THERMOPLASTIC SUBMERSIBLE PUMPS

PUMP SIZE: 4"

DIMENSIONS

5 GPM to 75 GPM

MODEL NAME: NS-E-0013 PUMP SIZE: 4" 13 GPM

HP	STAGES	MOTOR SIZE [inch]	A [inch]	D [inch] Max. diameter across cable guard	L [inch]	WEIGHT [lbs]
1/2	5	4	1¼ NPT	3.94	10.39	11
3/4	7	4	1¼ NPT	3.94	11.77	12
1	10	4	1¼ NPT	3.94	13.86	14
1½	12	4	1¼ NPT	3.94	15.24	15
2	17	4	1¼ NPT	3.94	18.66	21
3	21	4	1¼ NPT	3.94	22.60	23

MODEL NAME: NS-E-0018 PUMP SIZE: 4" 18 GPM

HP	STAGES	MOTOR SIZE [inch]	A [inch]	D [inch] Max. diameter across cable guard	L [inch]	WEIGHT [lbs]
3/4	6	4	1¼ NPT	3.94	12.09	11
1	8	4	1¼ NPT	3.94	13.78	13
1½	11	4	1¼ NPT	3.94	16.34	18
2	14	4	1¼ NPT	3.94	18.90	20
3	19	4	1¼ NPT	3.94	24.33	25
5	24	4	1¼ NPT	3.94	28.58	30
5	30	4	1¼ NPT	3.94	34.84	33

MODEL NAME: NS-E-0025 PUMP SIZE: 4" 25 GPM

HP	STAGES	MOTOR SIZE [inch]	A [inch]	D [inch] Max. diameter across cable guard	L [inch]	WEIGHT [lbs]
1	7	4	1¼ NPT	3.94	13.50	13
1½	9	4	1¼ NPT	3.94	15.39	15
2	11	4	1¼ NPT	3.94	17.24	18
3	15	4	1¼ NPT	3.94	20.98	22
5	22	4	1¼ NPT	3.94	28.74	28
5	26	4	1¼ NPT	3.94	33.66	31

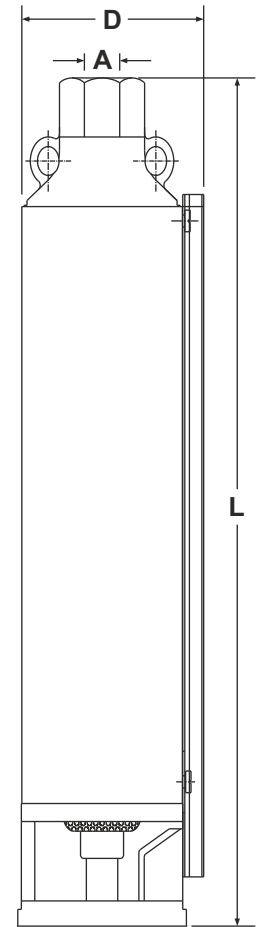

GLASS REINFORCED THERMOPLASTIC SUBMERSIBLE PUMPS

PUMP SIZE: 4"

DIMENSIONS

5 GPM to 75 GPM

MODEL NAME: NS-E-0033 PUMP SIZE: 4" 33 GPM

HP	STAGES	MOTOR SIZE [inch]	A [inch]	D [inch] Max. diameter across cable guard	L [inch]	WEIGHT [lbs]
1	6	4	2 NPT	3.94	14.92	15
1½	7	4	2 NPT	3.94	16.14	17
2	10	4	2 NPT	3.94	19.80	18
3	12	4	2 NPT	3.94	22.24	19
5	18	4	2 NPT	3.94	29.57	23
5	22	4	2 NPT	3.94	35.94	25
7½	28	4	2 NPT	3.94	43.27	30
7½	31	4	2 NPT	3.94	46.93	32

MODEL NAME: NS-E-0055 PUMP SIZE: 4" 55 GPM

HP	STAGES	MOTOR SIZE [inch]	A [inch]	D [inch] Max. diameter across cable guard	L [inch]	WEIGHT [lbs]
1½	5	4	2 NPT	3.94	17.83	18
2	7	4	2 NPT	3.94	21.93	20
3	9	4	2 NPT	3.94	26.02	22
5	11	4	2 NPT	3.94	30.12	24
5	13	4	2 NPT	3.94	35.71	26
5	15	4	2 NPT	3.94	39.80	29
7½	17	4	2 NPT	3.94	43.90	31
7½	19	4	2 NPT	3.94	47.99	33
7½	22	4	2 NPT	3.94	54.13	36

MODEL NAME: NS-E-0075 PUMP SIZE: 4" 75 GPM

HP	STAGES	MOTOR SIZE [inch]	A [inch]	D [inch] Max. diameter across cable guard	L [inch]	WEIGHT [lbs]
2	4	4	2 NPT	3.94	16.81	14
3	6	4	2 NPT	3.94	22.17	18
3	7	4	2 NPT	3.94	24.84	19
5	9	4	2 NPT	3.94	30.20	22
5	11	4	2 NPT	3.94	35.55	25
5	12	4	2 NPT	3.94	38.23	28
7½	14	4	2 NPT	3.94	43.58	31
7½	16	4	2 NPT	3.94	48.94	34

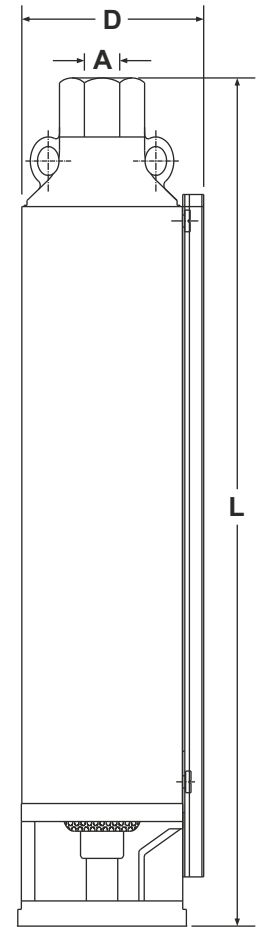

This page is intentionally left blank.

SLIM JIM THERMOPLASTIC SUBMERSIBLE PUMPS WITH STAINLESS STEEL END BELLS

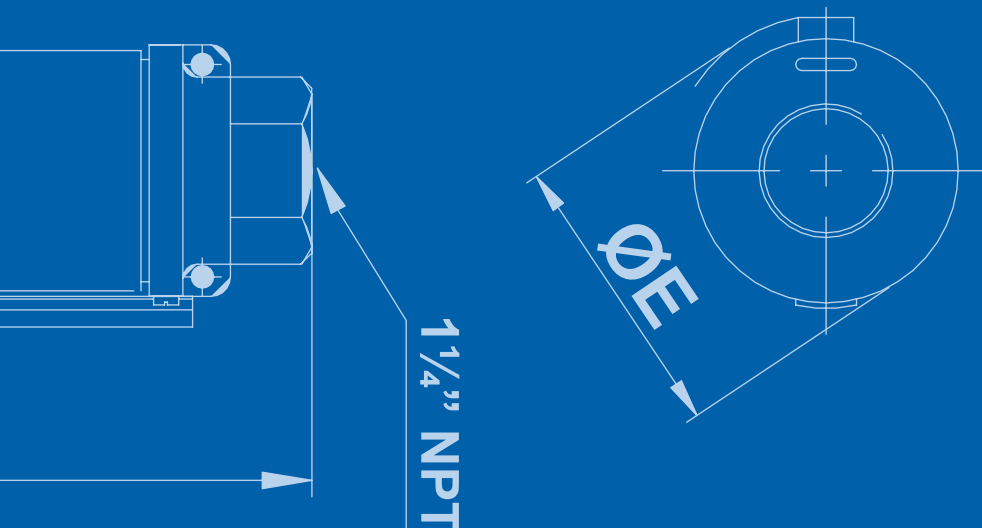

SLIM JIM THERMOPLASTIC SUBMERSIBLE PUMPS

PUMP SIZE: 4"

GENERAL DATA

7 GPM & 10 GPM

FEATURES

- ▶ SLIM JIM pumps are ideal for under sized 4" wells. The maximum diameter including cable guard is 3¾".
- ▶ Abrasion-resistant construction. Stainless steel bowl casing combined with front wear plate on floating impeller, ensures optimum resistance to abrasion.
- ▶ The suction case & discharge head are made of precision cast stainless steel, ensuring resistance to corrosion, durability and a sturdy coupling to the motor.
- ▶ Stainless steel oversized pump shaft guarantees an effective impeller drive.
- ▶ The non-return valve is spring loaded poppet type fitted in the discharge head to prevent any back flow of water and alleviate any water hammer to the pump, thus safeguarding impellers & diffusers.
- ▶ These pumps can be coupled to either the 4" Water Filled rewindable or Encapsulated or Oil Filled submersible motors.
- ▶ Units have left hand threads and are field serviceable with common tools and readily available repair parts.
- ▶ Face clearance and floating impeller stack provides itself as a superior sand handling, durable pump design.
- ▶ Impellers, diffusers and bearing spiders are constructed of corrosion resistant glass reinforced engineering composite material.
- ▶ The proprietary, engineered polymer bearing material is strong and resistant to abrasion & wear. The enclosed intermediate and upper bearing is mounted in a durable glass reinforced thermoplastic bearing spider for excellent abrasion resistance.
- ▶ Easy access to motor mounting nuts using standard open end wrench.
- ▶ Stainless steel casing is strong and corrosion resistant.

APPLICATIONS

- ▶ Residential
- ▶ Irrigation
- ▶ Industrial

OPERATING RANGE & CONDITIONS

	4" Pump
Flow ratings	7 & 10 GPM
Maximum head	700 feet
Pump ratings	0.5 - 1.5 hp
Liquid temperature	+32 °F to +113 °F
Max. sand content	50 ppm

SLIM JIM THERMOPLASTIC SUBMERSIBLE PUMPS

PUMP SIZE: 4"

MATERIAL OF CONSTRUCTION

7 GPM & 10 GPM

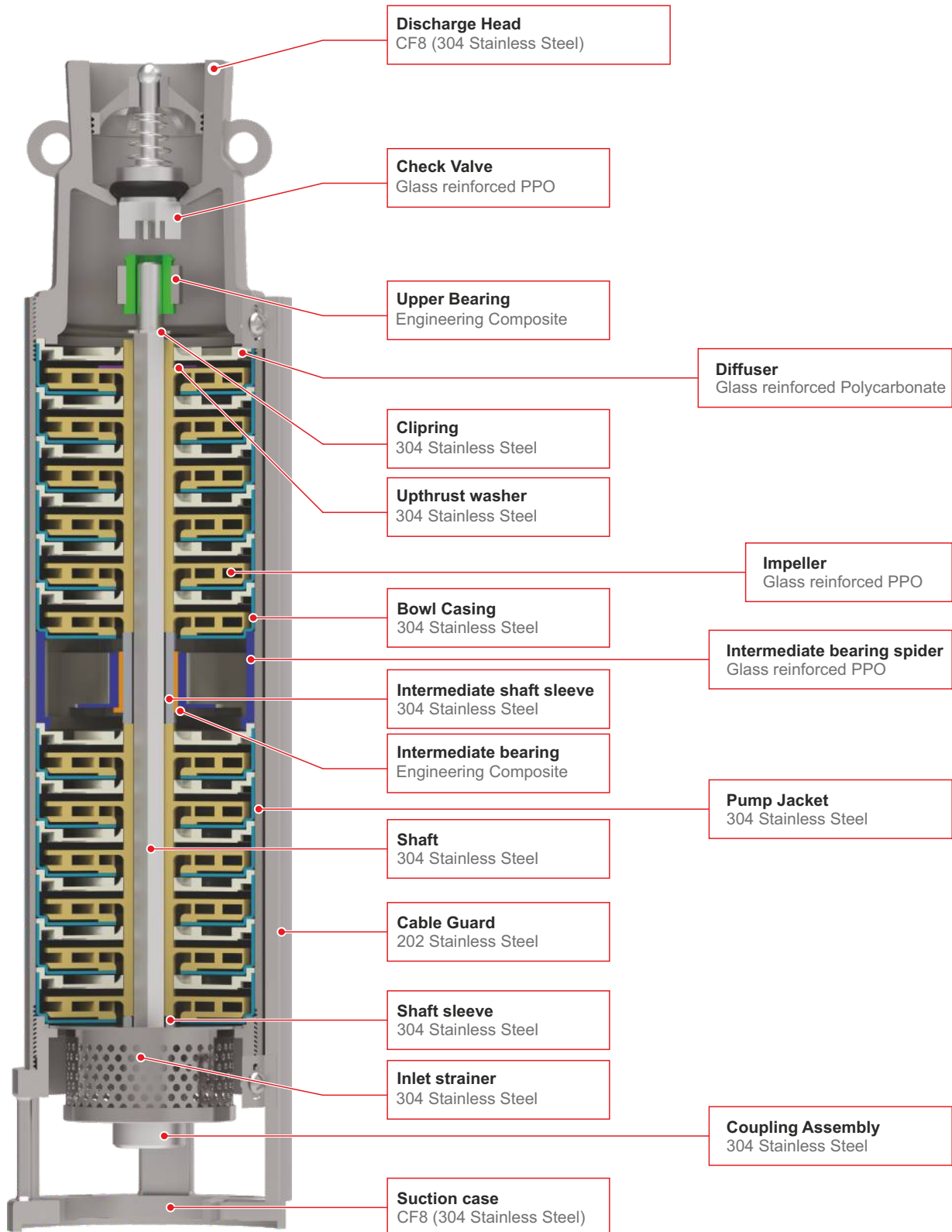

SLIM JIM THERMOPLASTIC SUBMERSIBLE PUMPS

PUMP SIZE: 4"

PERFORMANCE RANGE

7 GPM & 10 GPM

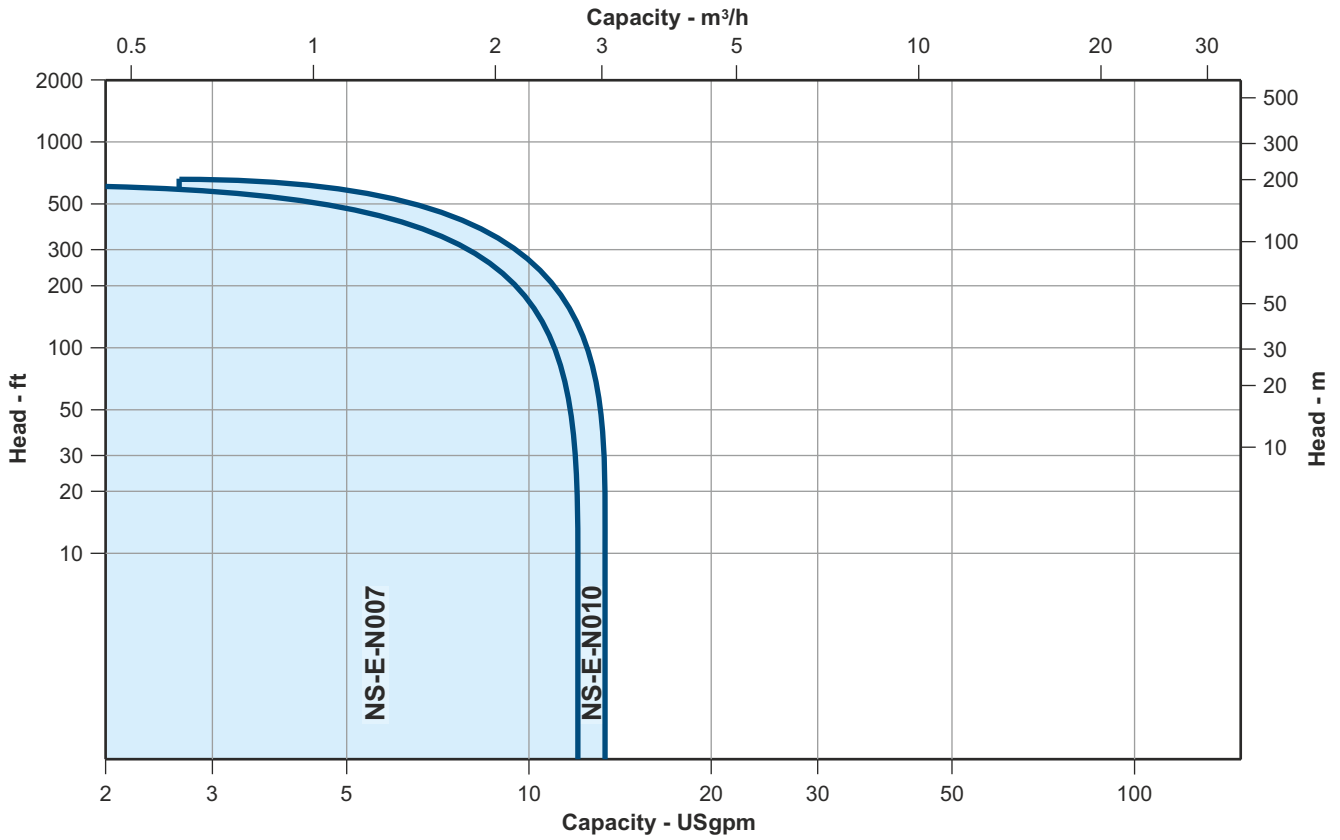

Pump Size	Model Name	Rated Flow
4" PUMP	NS-E-N007	7 GPM
4" PUMP	NS-E-N010	10 GPM

SLIM JIM THERMOPLASTIC SUBMERSIBLE PUMPS

PUMP SIZE: 4"

MODEL CODE

7 GPM & 10 GPM

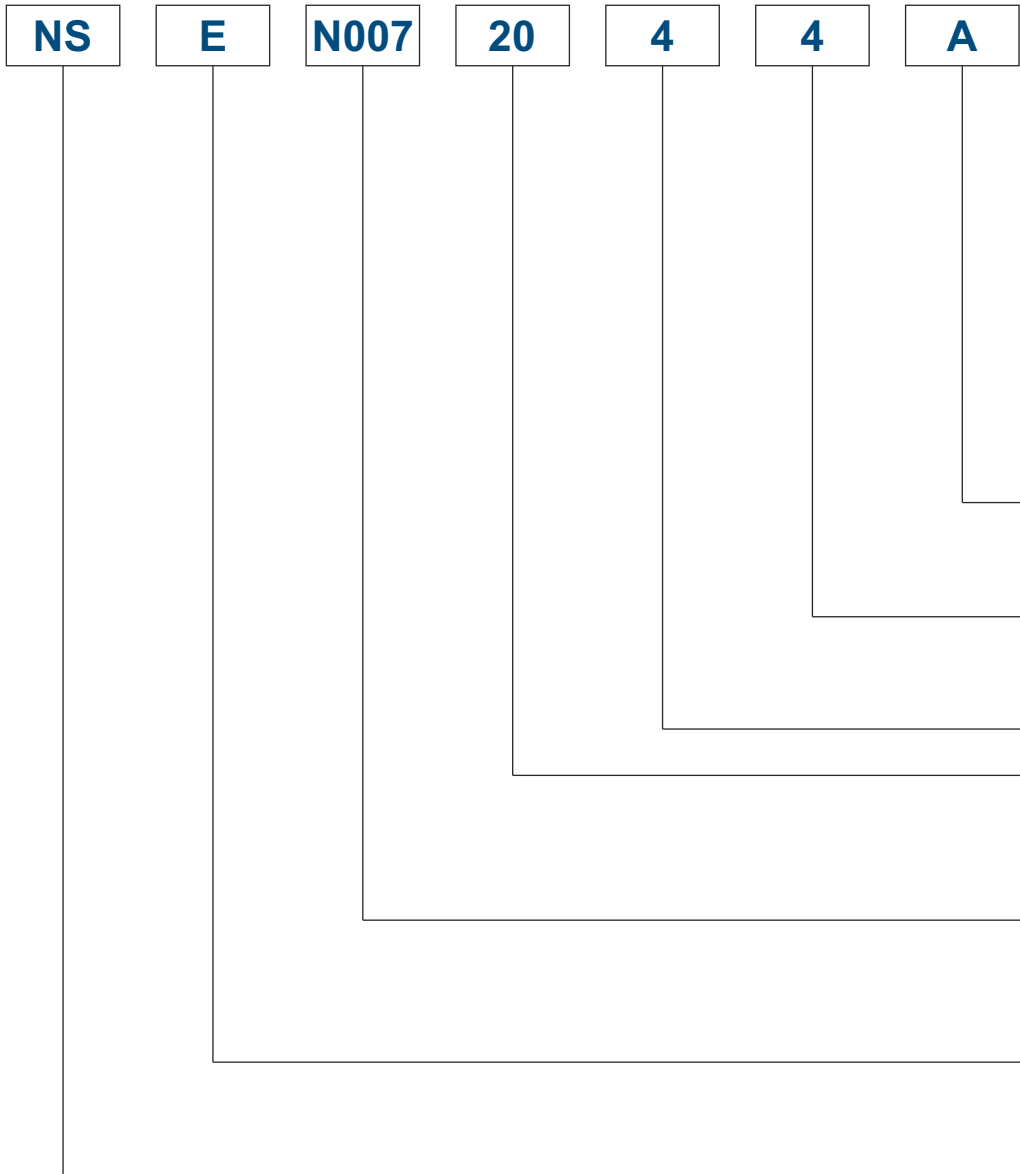

Discharge size NPT

Code	Size
A	1 1/4"
C	2"

Motor joining size

Code	Size
4	4"

Pump size

Code	Size
4	4"

Number of stages

Rated flow (GPM)

Code	GPM
N007	7 GPM
N010	10 GPM

Material of construction

Code	Material
E	Glass reinforced engineering composite

Series name

Code	Series
NS	Submersible pump

Example:

NS-E-N007-20-4-4-A = Submersible pump, Glass reinforced engineering composite material, 7 GPM, 20 stages, 4" Pump, 4" Motor joining, 1 1/4" Discharge size.

SLIM JIM THERMOPLASTIC SUBMERSIBLE PUMPS

PUMP SIZE: 4"

ORDER INFORMATION

7 GPM & 10 GPM

GPM	STAGES	MOTOR JOINING SIZE	ORDER NO. / MODEL CODE
7	11	4"	NS-E-N007-11-4-4-A
	15	4"	NS-E-N007-15-4-4-A
	20	4"	NS-E-N007-20-4-4-A
	25	4"	NS-E-N007-25-4-4-A
10	12	4"	NS-E-N010-12-4-4-A
	15	4"	NS-E-N010-15-4-4-A
	20	4"	NS-E-N010-20-4-4-A
	27	4"	NS-E-N010-27-4-4-A

SLIM JIM THERMOPLASTIC SUBMERSIBLE PUMPS

MODEL NAME: NS-E-N007

SELECTION CHART

7 GPM

RATINGS ARE IN GALLONS PER MINUTE (GPM)

HP	Stage	PSI	Depth to pumping water level (Lift) in feet																									
			20	40	60	80	100	120	140	160	180	200	220	240	260	280	300	350	400	450	500	600	700	800	900	1000		
1/2	11	0	11.6	11.0	10.5	9.9	9.3	8.7	8.0	7.3	6.5	5.6	4.7	3.8	2.6													
		20	10.3	9.7	9.1	8.5	7.8	7.1	6.3	5.4	4.5	3.5	2.0															
		30	9.6	9.0	8.4	7.7	6.9	6.2	5.3	4.3	3.3	2.0																
		40	9.0	8.3	7.6	6.8	6.0	5.1	4.1	3.0																		
		50	8.2	7.5	6.7	5.9	4.9	4.0	2.8																			
		60	7.5	6.5	5.8	4.9	3.9	2.7																				
Shut-off PSI			114	106	97	88	80	71	62	54	45	36	28	19	10													
3/4	15	0	11.7	11.3	10.9	10.5	10.1	9.7	9.3	8.8	8.3	7.8	7.2	6.7	6.1	5.4	4.7	2.8										
		20	10.8	10.4	10.0	9.6	9.1	8.7	8.2	7.6	7.1	6.5	5.9	5.2	4.5	3.8	3.0											
		30	10.3	9.9	9.5	9.0	8.6	8.1	7.5	7.0	6.4	5.8	5.2	4.4	3.7													
		40	9.8	9.4	9.0	8.5	8.0	7.5	6.9	6.3	5.7	5.0	4.3	3.6	2.8													
		50	9.4	8.9	8.3	7.9	7.4	6.8	6.2	5.6	4.9	4.2	3.4	2.5														
		60	8.8	8.3	7.8	7.3	6.8	6.2	5.5	4.8	4.1	3.4	2.4															
Shut-off PSI			159	150	142	133	124	116	107	98	90	81	72	64	55	46	38	16										
1	20	0			11.2	10.9	10.6	10.3	10.0	9.7	9.4	9.0	8.7	8.3	7.9	7.5	7.1	6.0	4.7	3.4								
		20	11.1	10.8	10.5	10.2	9.9	9.6	9.2	8.9	8.5	8.2	7.8	7.4	7.0	6.5	6.1	4.8	3.5									
		30	10.7	10.4	10.2	9.8	9.5	9.2	8.9	8.5	8.1	7.7	7.3	6.9	6.5	6.0	5.5	4.2	2.7									
		40	10.4	10.1	9.8	9.5	9.2	8.8	8.4	8.1	7.6	7.2	6.8	6.4	5.9	5.4	5.0	3.5										
		50	10.1	9.8	9.4	9.1	8.8	8.4	8.0	7.6	7.2	6.7	6.3	5.8	5.3	4.8	4.3	2.9										
		60	9.7	9.4	9.0	8.7	8.3	8.0	7.6	7.1	6.8	6.3	5.8	5.3	4.8	4.2	3.7											
Shut-off PSI			215	206	198	189	180	172	163	154	146	137	128	120	111	102	94	72	50	29								
1½	25	0		11.6	11.4	11.1	10.9	10.6	10.4	10.2	9.9	9.7	9.4	9.1	8.9	8.6	8.3	7.5	6.6	5.7	4.8	2.3						
		20	11.3	11.0	10.8	10.6	10.3	10.1	9.8	9.6	9.3	9.0	8.7	8.5	8.2	7.8	7.5	6.8	5.8	4.8	3.8							
		30	11.0	10.7	10.5	10.3	10.1	9.8	9.6	9.3	9.0	8.7	8.5	8.2	7.8	7.5	7.2	6.3	5.4	4.3	3.2							
		40	10.7	10.5	10.3	10.0	9.8	9.5	9.3	9.0	8.7	8.4	8.1	7.8	7.5	7.2	6.8	5.9	4.9	3.8	2.5							
		50	10.5	10.2	10.0	9.8	9.5	9.2	9.0	8.7	8.4	8.1	7.7	7.4	7.1	6.8	6.4	5.4	4.4	3.3								
		60	10.2	10.0	9.7	9.5	9.2	8.9	8.6	8.3	8.0	7.7	7.4	7.0	6.7	6.3	6.0	5.0	3.9	2.7								
Shut-off PSI			271	262	254	245	236	228	219	210	202	193	184	176	167	158	150	128	106	84	63	19						

MOST EFFICIENT OPERATING RANGE.
 PERFORMANCES ARE SUBJECT TO PERIODIC CHANGES DUE TO CONTINUOUS IMPROVEMENTS.

SLIM JIM THERMOPLASTIC SUBMERSIBLE PUMPS

MODEL NAME: NS-E-N010

SELECTION CHART

10 GPM

RATINGS ARE IN GALLONS PER MINUTE (GPM)

HP	Stage	PSI	Depth to pumping water level (Lift) in feet																								
			20	40	60	80	100	120	140	160	180	200	220	240	260	280	300	350	400	450	500	600	700	800	900	1000	
1/2	12	0	12.7	12.2	11.8	11.2	10.7	10.1	9.5	9.0	8.3	7.5	6.8	5.9	4.9	3.5											
		20	11.6	11.0	10.5	9.9	9.4	8.7	8.0	7.4	6.5	5.6	4.4	3.0													
		30	11.0	10.5	9.8	9.3	8.6	8.0	7.3	6.5	5.4	4.2	2.9														
		40	10.4	9.8	9.2	8.5	7.9	7.1	6.2	5.3	4.2	2.5															
		50	9.7	9.0	8.4	7.8	7.0	6.0	5.2	3.9	2.4																
		60	8.8	8.3	7.6	6.9	6.0	5.0	3.6	2.0																	
Shut-off PSI			126	118	109	100	92	83	74	66	57	48	40	31	22	14											
3/4	15	0	12.9	12.5	12.1	11.7	11.2	10.8	10.4	9.9	9.5	8.9	8.4	7.8	7.3	6.6	6.0	3.5									
		20	12.0	11.5	11.1	10.7	10.3	9.8	9.3	8.8	8.3	7.7	7.0	6.4	5.7	5.0	3.7										
		30	11.5	11.0	10.6	10.2	9.7	9.2	8.7	8.2	7.5	7.0	6.2	5.5	4.7	3.7	2.4										
		40	11.0	10.5	10.1	9.6	9.1	8.6	8.0	7.5	6.9	6.2	5.5	4.5	3.4	2.4											
		50	10.5	10.0	9.5	9.0	8.5	8.0	7.4	6.8	6.1	5.2	4.3	3.4													
		60	10.0	9.5	9.0	8.5	7.9	7.3	6.7	6.0	5.2	4.2	3.0														
Shut-off PSI			160	151	143	134	125	117	108	99	91	82	73	65	56	47	39	17									
1	20	0	12.9	12.7	12.4	12.1	11.8	11.4	11.1	10.8	10.5	10.1	9.8	9.4	9.0	8.7	8.3	7.2	5.9	4.3							
		20	12.3	12.0	11.7	11.4	11.0	10.6	10.4	10.0	9.7	9.3	9.0	8.5	8.2	7.7	7.3	6.1	4.5								
		30	11.9	11.6	11.3	11.0	10.7	10.3	10.0	9.7	9.3	8.8	8.5	8.1	7.7	7.3	6.7	5.4	3.5								
		40	11.5	11.2	10.9	10.6	10.3	9.9	9.6	9.2	8.8	8.5	8.0	7.6	7.2	6.7	6.2	4.6	2.3								
		50	11.2	10.9	10.5	10.2	9.9	9.5	9.2	8.7	8.4	8.0	7.5	7.0	6.6	6.1	5.5	3.7									
		60	10.8	10.5	10.2	9.8	9.5	9.1	8.7	8.3	7.9	7.5	7.0	6.5	6.0	5.4	4.7	2.5									
Shut-off PSI			216	208	199	190	182	173	164	156	147	138	130	121	112	104	95	73	52	30							
1½	27	0	13.0	12.8	12.6	12.4	12.2	11.9	11.7	11.5	11.2	11.0	10.7	10.5	10.3	10.0	9.7	9.1	8.3	7.5	6.7	4.5					
		20	12.5	12.3	12.1	11.9	11.6	11.4	11.2	10.9	10.7	10.4	10.2	9.9	9.7	9.4	9.1	8.4	7.6	6.8	5.8	3.0					
		30	12.3	12.0	11.8	11.6	11.3	11.1	10.9	10.7	10.4	10.2	9.9	9.6	9.4	9.1	8.8	8.0	7.2	6.3	5.3						
		40	12.0	11.8	11.6	11.4	11.0	10.8	10.6	10.3	10.1	9.8	9.6	9.4	9.0	8.7	8.5	7.7	6.8	5.8	4.7						
		50	11.8	11.5	11.3	10.9	10.8	10.6	10.3	10.0	9.7	9.5	9.3	9.0	8.7	8.4	8.1	7.3	6.4	5.4	4.1						
		60	11.5	11.2	11.0	10.7	10.5	10.3	10.0	9.7	9.5	9.2	9.0	8.7	8.4	8.1	7.7	6.9	5.9	4.8							
Shut-off PSI			295	286	278	269	260	252	243	234	226	217	208	200	191	182	174	152	130	109	87	44					

 MOST EFFICIENT OPERATING RANGE.
 PERFORMANCES ARE SUBJECT TO PERIODIC CHANGES DUE TO CONTINUOUS IMPROVEMENTS.

SLIM JIM THERMOPLASTIC SUBMERSIBLE PUMPS

MODEL NAME: NS-E-N007

PERFORMANCE CURVE

7 GPM

Nominal RPM	3450
Curve based on clear water @	68°F

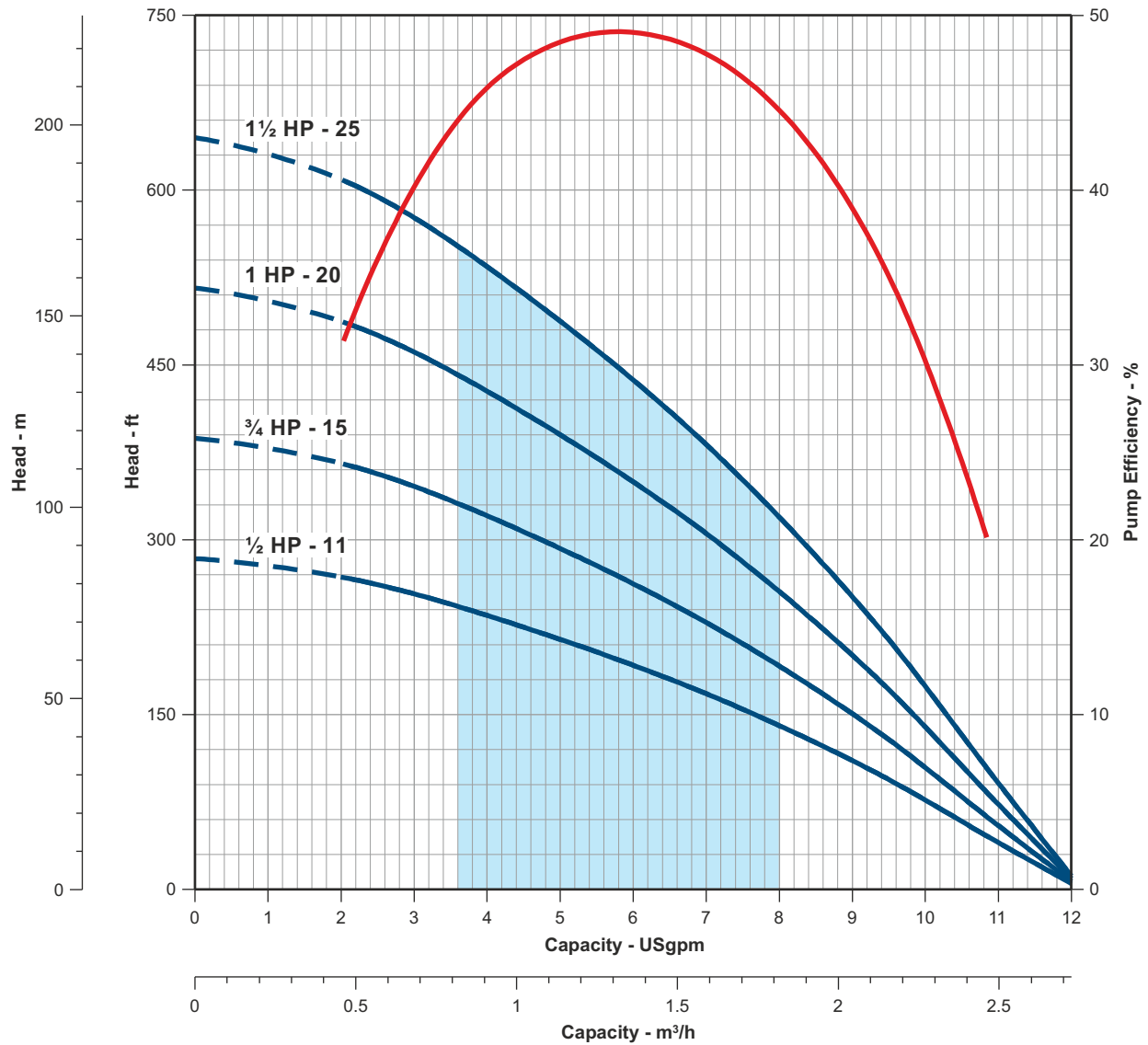

■ BEST EFFICIENCY REGION
— RECOMMENDED PUMP OPERATING RANGE
 PERFORMANCE BASED ON TEST ACCEPTANCE - ISO 9906:2012 3B.
 PERFORMANCES ARE SUBJECT TO PERIODIC CHANGES DUE TO CONTINUOUS IMPROVEMENTS.

SLIM JIM THERMOPLASTIC SUBMERSIBLE PUMPS

MODEL NAME: NS-E-N010

PERFORMANCE CURVE

10 GPM

Nominal RPM	3450
Curve based on clear water @	68°F

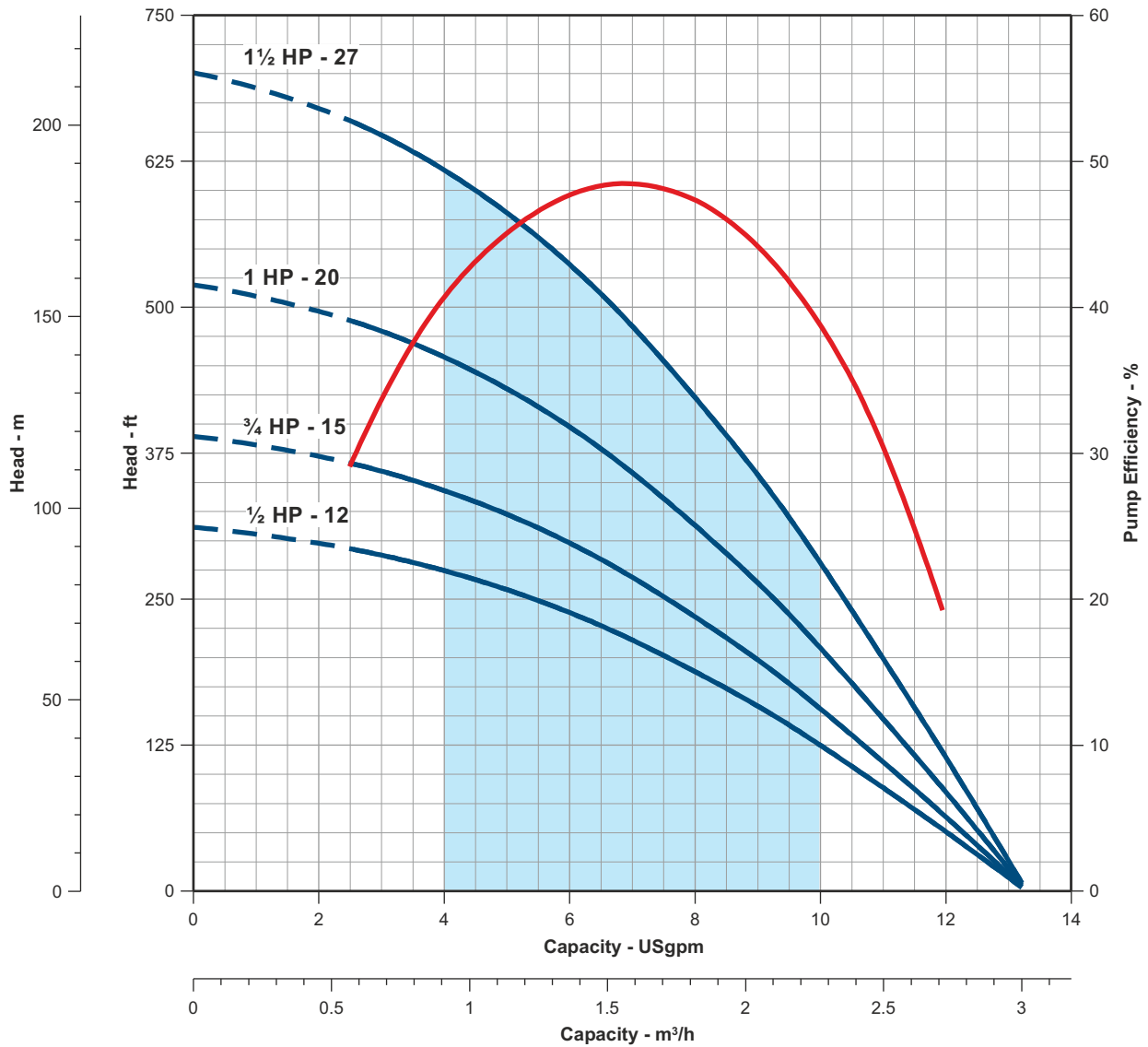

■ BEST EFFICIENCY REGION
— RECOMMENDED PUMP OPERATING RANGE
 PERFORMANCE BASED ON TEST ACCEPTANCE - ISO 9906:2012 3B.
 PERFORMANCES ARE SUBJECT TO PERIODIC CHANGES DUE TO CONTINUOUS IMPROVEMENTS.

SLIM JIM THERMOPLASTIC SUBMERSIBLE PUMPS

PUMP SIZE: 4"

DIMENSIONS

7 GPM & 10 GPM

MODEL NAME: NS-E-N007 PUMP SIZE: 4" 7 GPM

HP	STAGES	MOTOR SIZE [inch]	A [inch]	D [inch] Max. diameter across cable guard	L [inch]	WEIGHT [lbs]
1/2	11	4	1¼ NPT	3.75	13.31	18
3/4	15	4	1¼ NPT	3.75	15.83	20
1	20	4	1¼ NPT	3.75	18.98	21
1½	25	4	1¼ NPT	3.75	23.31	24

MODEL NAME: NS-E-N010 PUMP SIZE: 4" 10 GPM

HP	STAGES	MOTOR SIZE [inch]	A [inch]	D [inch] Max. diameter across cable guard	L [inch]	WEIGHT [lbs]
1/2	12	4	1¼ NPT	3.75	14.65	13
3/4	15	4	1¼ NPT	3.75	16.69	16
1	20	4	1¼ NPT	3.75	20.16	22
1½	27	4	1¼ NPT	3.75	26.14	27

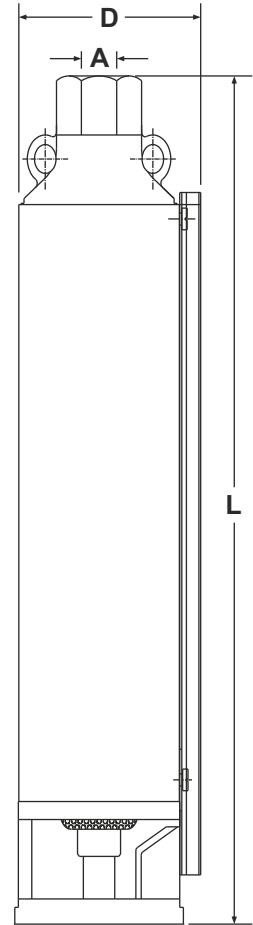

Limited Warranty for Deep Well Submersible Products

Northam Inc. provides a comprehensive warranty to ensure product quality and customer satisfaction. Please read the details below to understand the coverage, conditions, exclusions, and processes associated with Northam's warranty policy.

1. Standard Warranty Period

For registered dealers and distributors,

Northam offers for All Pump ends, 4-inch motors and 6-inch motors a **24-month warranty from the date of invoice of Northam.**

All 8", and above motors carry **18-month warranty** from the date of invoice of Northam.

All 4-inch motors and any accessories supplied by Northam but are manufactured by third parties will carry a **12-month warranty from the date of invoice of Northam.**

2. Warranty Coverage

Northam Inc. warrants that all products Shall.

- I. Be free from defects in design, except where goods are manufactured to specific customer design requirements.
- II. Meet the applicable specifications, drawings, and technical requirements.
- III. Be free from defects in materials or workmanship.
- IV. Be merchantable and suitable for the intended applications as specified by Northam.
- V. Be delivered free of liens, encumbrances, or third-party claims.
- VI. For **clean water applications only.**

3. Warranty Remedies

Northam reserves the right to address valid warranty claims by **repairing, replacing, refurbishing, or exchanging** the returned product with an item of equal or superior quality. If a product is no longer available, Northam may provide a replacement product with similar or enhanced features.

Northam practices a field scrap policy, allowing defective products to be scrapped in the field if authorized by Northam or its designated agent. This policy streamlines the warranty process, minimizing downtime and ensuring efficient handling of claims.

If required for evaluation, buyers must return the product to Northam's designated location, prepaying any associated shipping costs. Warranty determinations will be made solely by Northam's technical team. Northam will cover the shipping cost for repaired or replaced products, adhering to the original shipment terms.

4. Warranty Exclusions and Conditions that Void Warranty

This warranty will be voided under any of the following conditions but not limited to:

- I. Operational Issues:** Dry running of pumps, impure water containing sand or sediment, or installation without adequate protection systems.
- II. External Damage or Misuse:** Cosmetic damage, accidents, misuse, abuse, negligence, improper installation operation, or maintenance.
- III. Unauthorized Modifications:** Unauthorized alterations, attempted repairs, or servicing by anyone other than a Northam-authorized service provider.
- IV. Incorrect Application/Installation:** Installation errors or incompatible accessories and control panels.
- V. Environmental or External Factors:** Acts of God or natural disasters, water hammer, electrical surges, upthrust damages due to improper pump selection, improper control settings, and connections.
- VI. Unauthorized Purchases:** Products purchased from internet, non-authorized Northam dealers or distributors are ineligible.

Others: Other reasons beyond Northam's control. Some examples of motor/pump/control failures that are not covered under this policy include but are not limited to: absence of a check valve internal or external, top feeding wells without a motor flow sleeve, water hammer, electrical surges, and lightning incidences, improper control setting/connections and up thrust damage. Refer to the Northam Inc. Installation manual for additional details.

Additional exclusions apply for normal wear items, including pump shaft bush, capacitors, and other components subject to routine maintenance.

5. Required Documentation for Warranty Claims

To process a warranty claim, the following information must be provided:

- **Customer Name**
- **Return Request Date**
- **Purchase Place and Date**
- **Order Number**
- **Contact Information** (including name, phone number, and email)
- **Product Serial Number**
- **Quantity of items to return**
- **Detailed Description of the Problem** (include photos or videos if applicable to aid in diagnostic analysis)

Please note: Products returned without adequate or secure packing which could hinder testing may be rejected.

6. Disclaimer

Northam's Limited Warranty supersedes any oral statements made by Northam representatives, sellers, or third parties regarding product sales. Oral statements should not be relied upon as they do not constitute a warranty or form any part of the sales contract. The buyer's exclusive remedy under this warranty is limited to Northam's choice of repairing, replacing, or refunding the purchase price of the product, provided it is returned in accordance with Northam's return instructions.

The cost of shipping a repaired or replaced product to the buyer will be covered by Northam under the same shipping terms as the original purchase. However, the buyer will assume all other costs, including those associated with dismantling, removal, reinstallation, and any labor, materials, or incidental expenses related to warranty claims. Northam will not be liable for any incidental or consequential expenses arising from the repair, replacement, or return of a product under this Limited Warranty.

FOR EXTENDED WARRANTY CONTACT THE NORTHAM TEAM



Northam Inc.

995/C Griffin Pond Road, Clarks Summit, PA 18411, USA
Phone : +1-570-659-7200, Email : sales@northam-inc.com

Product Improvement and changes are a continuous process at 'Northam'. The data given in this publication is therefore subject to revision.