

NM SERIES

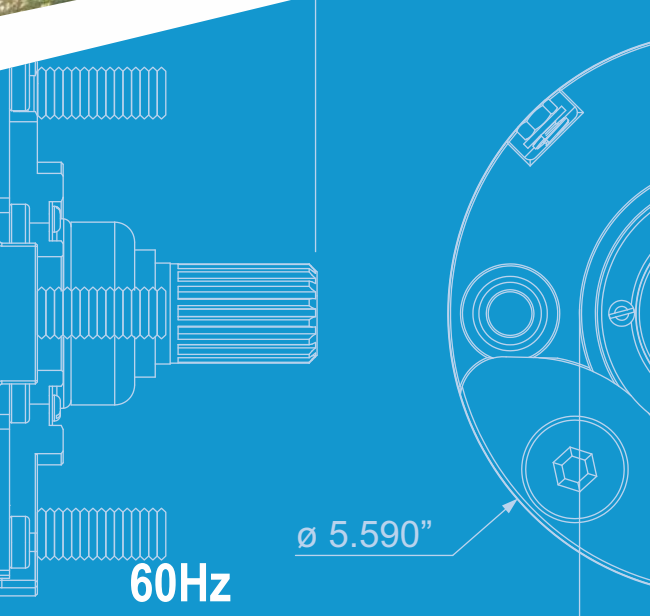

SUBMERSIBLE MOTORS

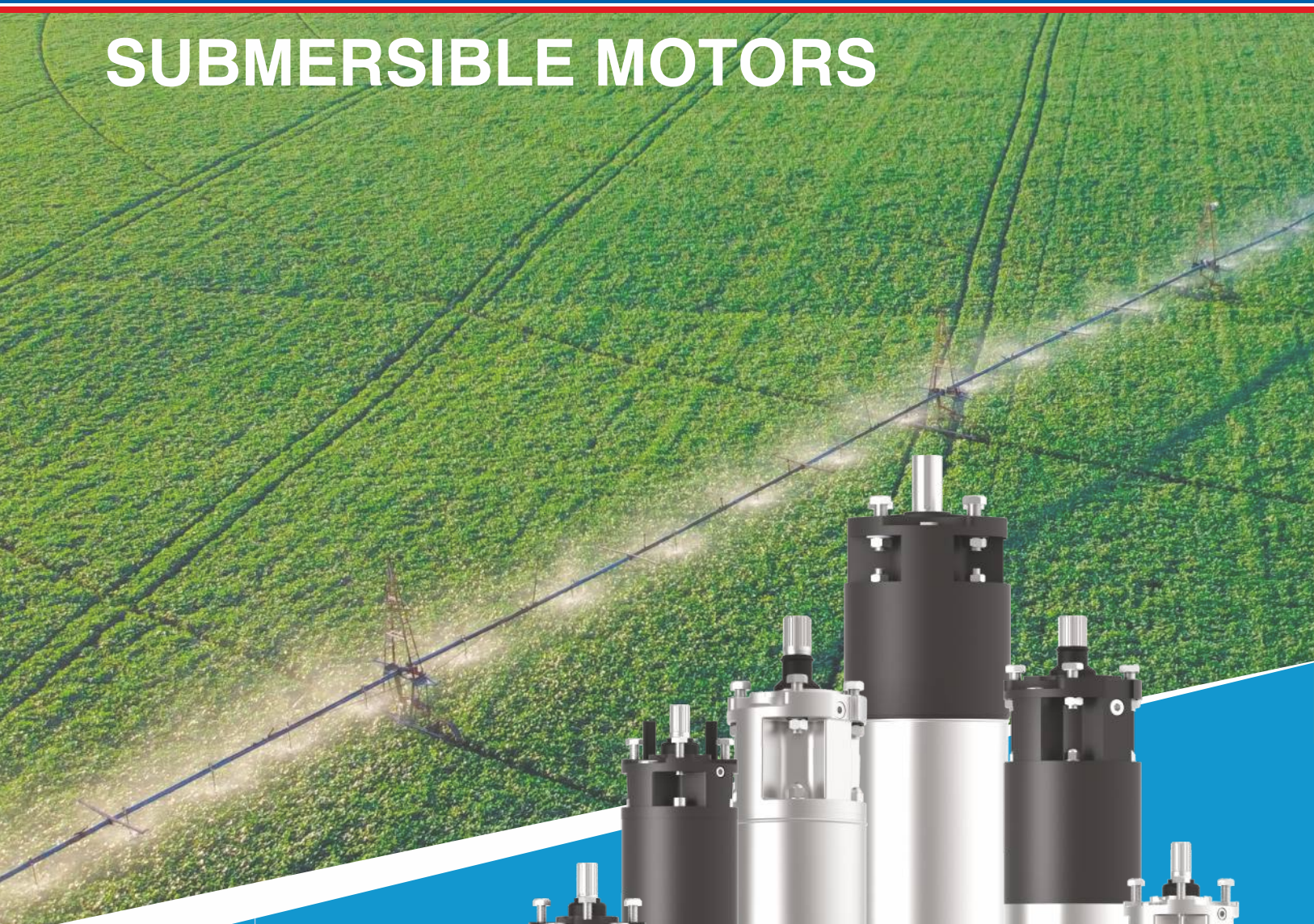

60Hz

$\varnothing 5.590''$



PRODUCT CATALOGUE

www.northam-inc.com

SUBMERSIBLE MOTORS

CONTENTS

Model Code	3
6" Submersible Motor	
General Data	4
Material of Construction	6
Order Information	10
Dimensions	11
Performance Data	12
8" Submersible Motor	
General Data	13
Material of Construction	15
Order Information	17
Dimensions	18
Performance Data	19
10" Submersible Motor	
General Data	20
Material of Construction	22
Order Information	23
Dimensions	24
Performance Data	25

SUBMERSIBLE MOTORS

0.5 HP to 250 HP
MODEL CODE
MOTOR SIZE: 4", 6", 8", 10"

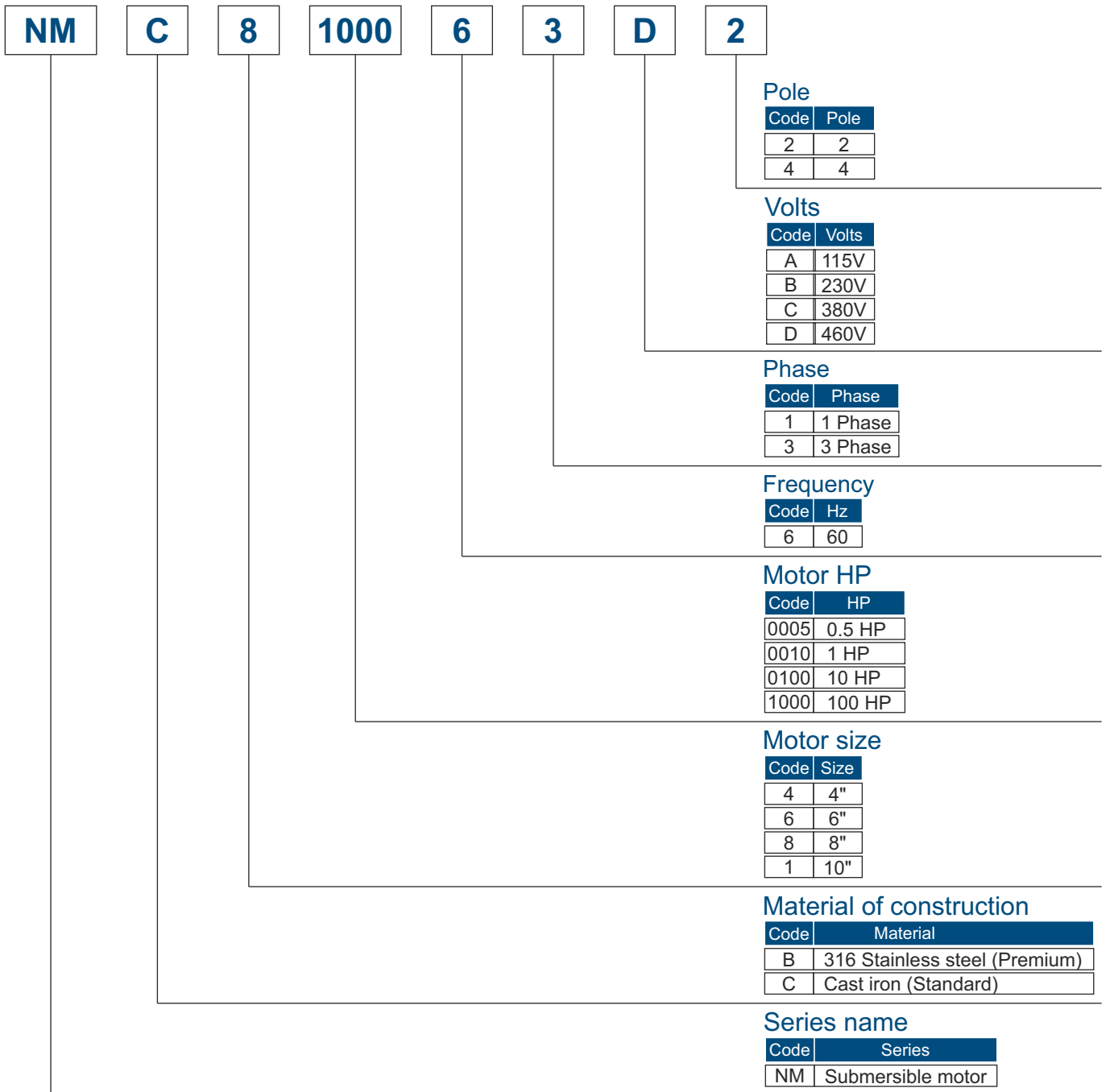

SUBMERSIBLE MOTORS

5 HP to 60 HP

GENERAL DATA

MOTOR SIZE: 6"

SUITABLE WELL SIZE

- ▶ These motors are designed and sized for installation in 6" diameter or larger water wells.

FEATURES

- ▶ Heavy duty, rewindable, water filled submersible motor.
- ▶ Stainless steel splined shaft
- ▶ Equipped with Carbon/SiC mechanical shaft seal.
- ▶ Water lubricated heavy duty radial and axial thrust bearings.
- ▶ Counter thrust bearing.
- ▶ Motors are factory-filled with clean water + Glycol mixture.
- ▶ High efficiency electrical design (lower operating cost).
- ▶ Tropicalized design (lower winding temperature).
- ▶ 6" NEMA coupling flange.
- ▶ Pressure compensation diaphragm.



SPECIAL FEATURES ON-REQUEST

- ▶ PT 100 temperature sensor.
- ▶ 50 Hz, voltage and HPs not listed in this catalog.
- ▶ Double cable for Star - Delta operation.

CABLE DATA

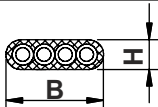
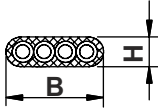
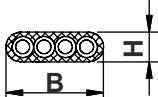
HP	Phase	Type of start	Cable x Lead x Size (AWG)	Length [ft]	H [inch]	B [inch]	
5 - 25	3	DOL	1 x 4 x 10 AWG	13	0.37	1.04	
30 - 60	3	DOL	1 x 4 x 8 AWG	13	0.45	1.22	
5 - 15	1	DOL	1 x 4 x 10 AWG	13	0.37	1.04	

SUBMERSIBLE MOTORS

5 HP to 60 HP

GENERAL DATA

MOTOR SIZE: 6"

SPECIFICATIONS

	Motor construction	
	Standard	Premium stainless steel
Frequency	60 Hz	60 Hz
Motor ratings	3 phase - 5 to 60 HP 1 phase - 5 to 15 HP	3 phase - 5 to 60 HP
Voltage (Tolerance +10% / -15%)	3 phase - 230 V, 460 V 1 phase - 230 V	3 phase - 230 V, 460 V
Pole/RPM	2 Pole / 3450 RPM	2 Pole / 3450 RPM
Degree of protection	IP 68	IP 68
Duty rating	Continuous	Continuous
Ambient temperature	104 °F / 40 °C	104 °F / 40 °C
Rotation	3 phase - CCW & CW 1 phase - CCW & CW	3 phase - CCW & CW
Maximum nos. of starts/hour	5 to 30 HP - 20 40 to 60 HP - 15	5 to 30 HP - 20 40 to 60 HP - 15
Minimum cooling flow along the motor	5 to 20 HP - 0.5 ft/sec 25 to 60 HP - 1 ft/sec	5 to 20 HP - 0.5 ft/sec 25 to 60 HP - 1 ft/sec
Maximum submerged depth	820 feet / 250 metres	820 feet / 250 metres
Mounting	Vertical	Vertical

NOTE: SPECIFICATIONS ARE SUBJECT TO PERIODIC CHANGES DUE TO CONTINUOUS IMPROVEMENTS.

STANDARD SUBMERSIBLE MOTORS

5 HP to 25 HP

MATERIAL OF CONSTRUCTION

MOTOR SIZE: 6"

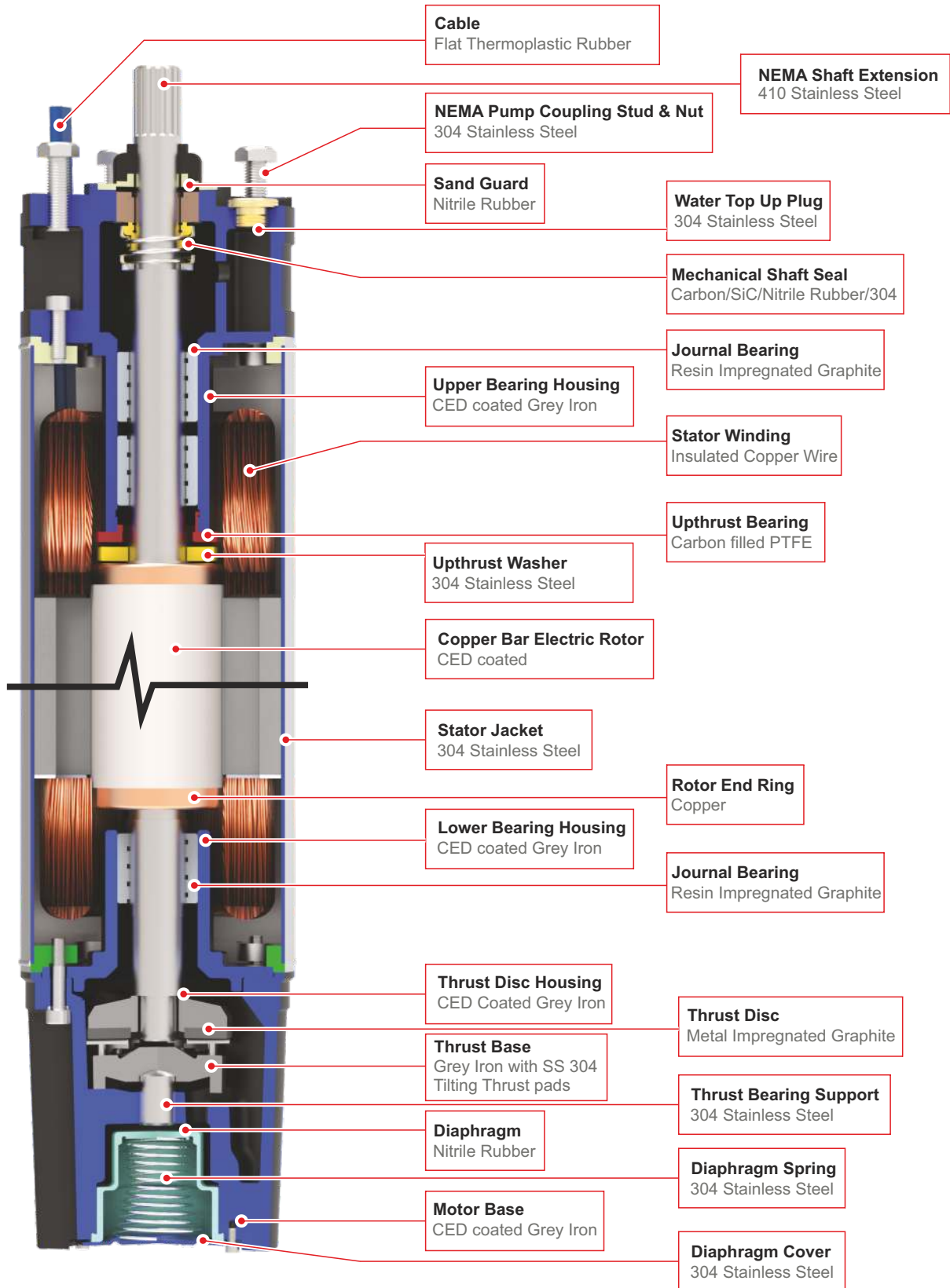

STANDARD SUBMERSIBLE MOTORS

30 HP to 60 HP

MATERIAL OF CONSTRUCTION

MOTOR SIZE: 6"

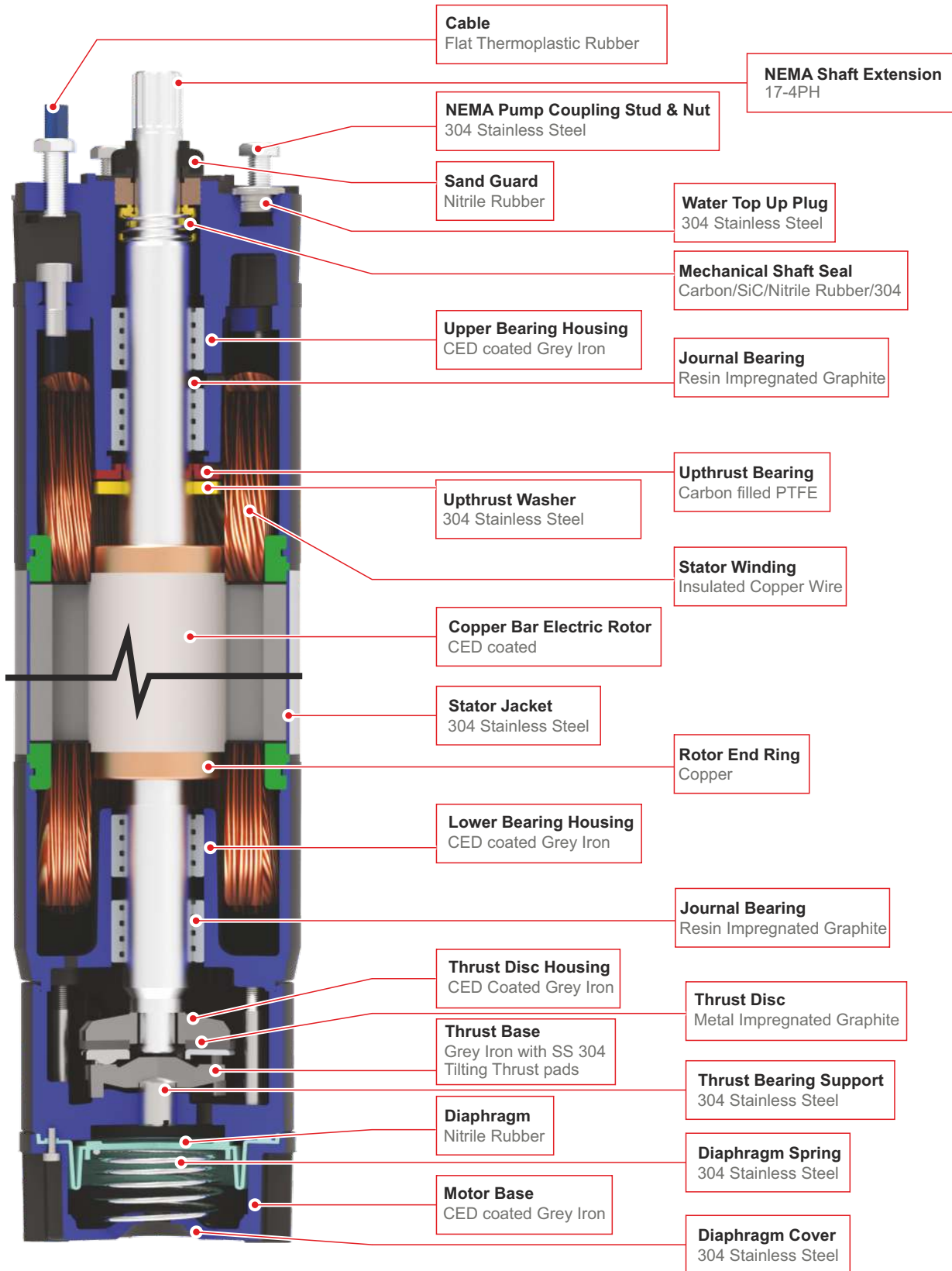

PREMIUM STAINLESS STEEL SUBMERSIBLE MOTORS

5 HP to 25 HP

MATERIAL OF CONSTRUCTION

MOTOR SIZE: 6"

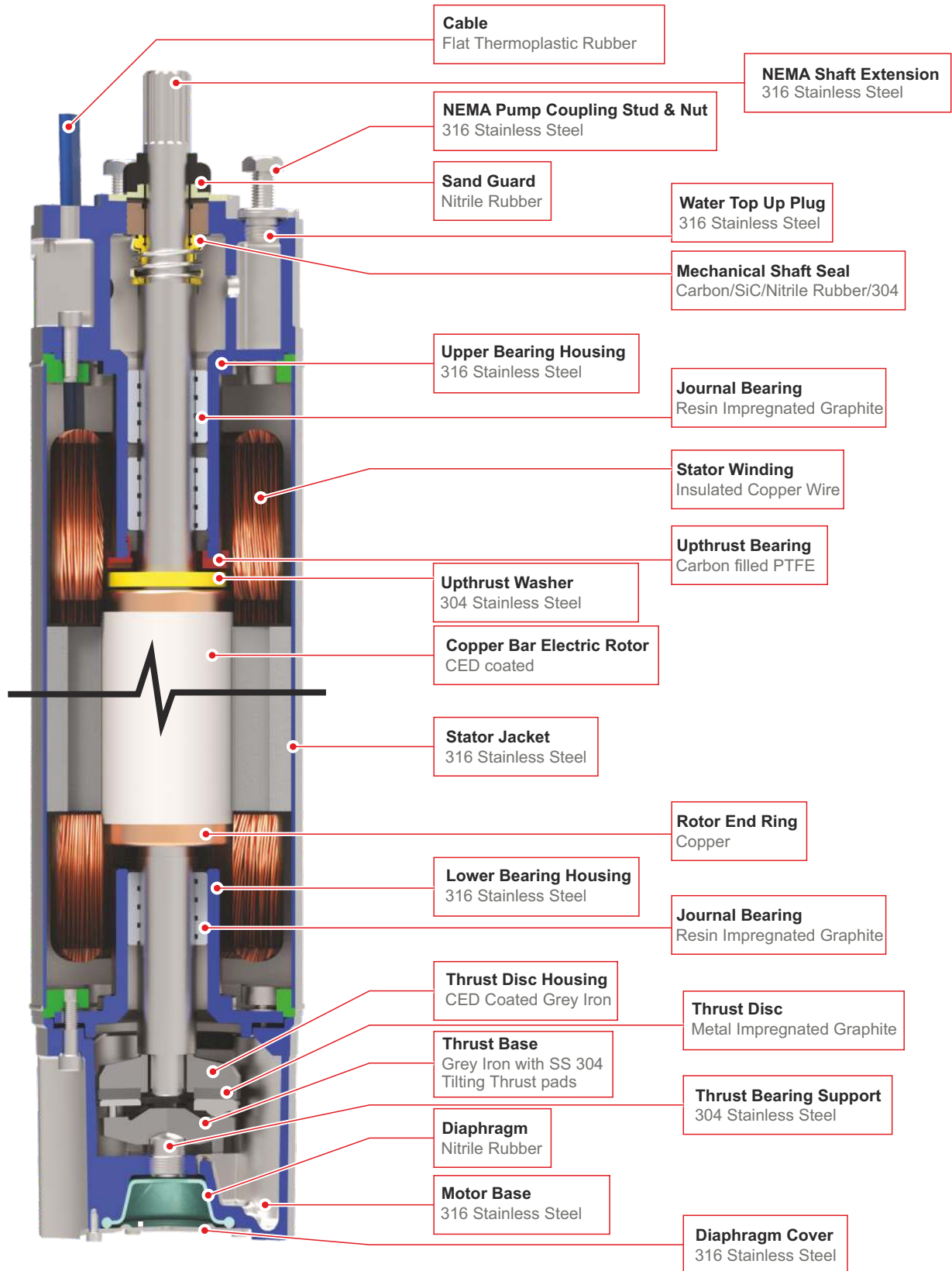

PREMIUM STAINLESS STEEL SUBMERSIBLE MOTORS

30 HP to 60 HP

MATERIAL OF CONSTRUCTION

MOTOR SIZE: 6"

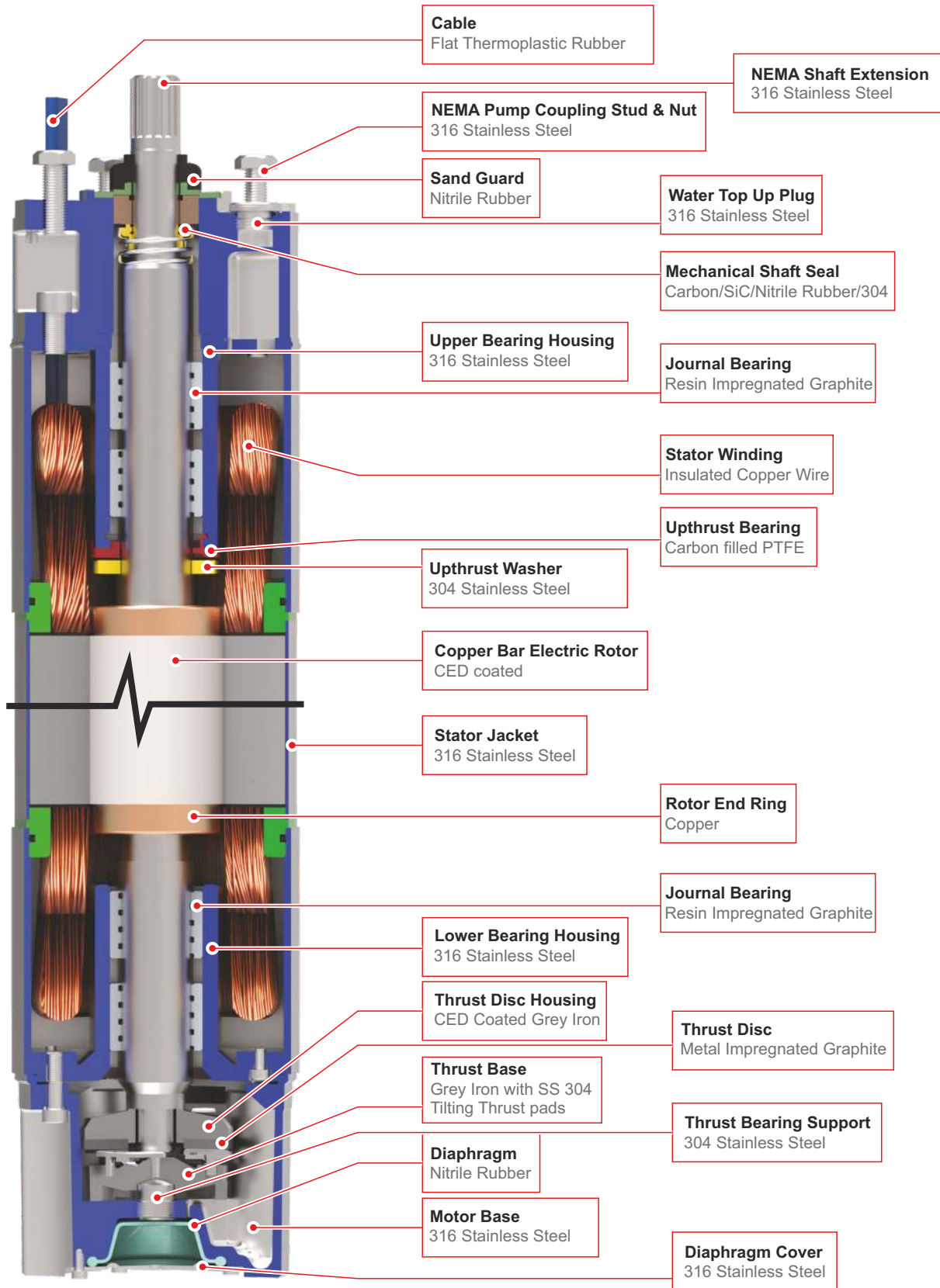

SUBMERSIBLE MOTORS

5 HP to 60 HP

ORDER INFORMATION

MOTOR SIZE: 6"

HP	Hz	PHASE	VOLTS	POLE	MOTOR SIZE	ORDER NO. / MODEL CODE	
						STANDARD	PREMIUM STAINLESS STEEL
5	60	3	230	2	6"	NM-C-6-0050-6-3-B-2	NM-B-6-0050-6-3-B-2
	60	3	460	2	6"	NM-C-6-0050-6-3-D-2	NM-B-6-0050-6-3-D-2
7½	60	3	230	2	6"	NM-C-6-0075-6-3-B-2	NM-B-6-0075-6-3-B-2
	60	3	460	2	6"	NM-C-6-0075-6-3-D-2	NM-B-6-0075-6-3-D-2
10	60	3	230	2	6"	NM-C-6-0100-6-3-B-2	NM-B-6-0100-6-3-B-2
	60	3	460	2	6"	NM-C-6-0100-6-3-D-2	NM-B-6-0100-6-3-D-2
15	60	3	230	2	6"	NM-C-6-0150-6-3-B-2	NM-B-6-0150-6-3-B-2
	60	3	460	2	6"	NM-C-6-0150-6-3-D-2	NM-B-6-0150-6-3-D-2
20	60	3	230	2	6"	NM-C-6-0200-6-3-B-2	NM-B-6-0200-6-3-B-2
	60	3	460	2	6"	NM-C-6-0200-6-3-D-2	NM-B-6-0200-6-3-D-2
25	60	3	230	2	6"	NM-C-6-0250-6-3-B-2	NM-B-6-0250-6-3-B-2
	60	3	460	2	6"	NM-C-6-0250-6-3-D-2	NM-B-6-0250-6-3-D-2
30	60	3	230	2	6"	NM-C-6-0300-6-3-B-2	NM-B-6-0300-6-3-B-2
	60	3	460	2	6"	NM-C-6-0300-6-3-D-2	NM-B-6-0300-6-3-D-2
40	60	3	230	2	6"	NM-C-6-0400-6-3-B-2	NM-B-6-0400-6-3-B-2
	60	3	460	2	6"	NM-C-6-0400-6-3-D-2	NM-B-6-0400-6-3-D-2
50	60	3	230	2	6"	NM-C-6-0500-6-3-B-2	NM-B-6-0500-6-3-B-2
	60	3	460	2	6"	NM-C-6-0500-6-3-D-2	NM-B-6-0500-6-3-D-2
60	60	3	230	2	6"	NM-C-6-0600-6-3-B-2	NM-B-6-0600-6-3-B-2
	60	3	460	2	6"	NM-C-6-0600-6-3-D-2	NM-B-6-0600-6-3-D-2
5	60	1	230	2	6"	NM-C-6-0050-6-1-B-2	NM-B-6-0050-6-1-B-2
7½	60	1	230	2	6"	NM-C-6-0075-6-1-B-2	NM-B-6-0075-6-1-B-2
10	60	1	230	2	6"	NM-C-6-0100-6-1-B-2	NM-B-6-0100-6-1-B-2
15	60	1	230	2	6"	NM-C-6-0150-6-1-B-2	NM-B-6-0150-6-1-B-2

SUBMERSIBLE MOTORS

5 HP to 60 HP

DIMENSIONS

MOTOR SIZE: 6"

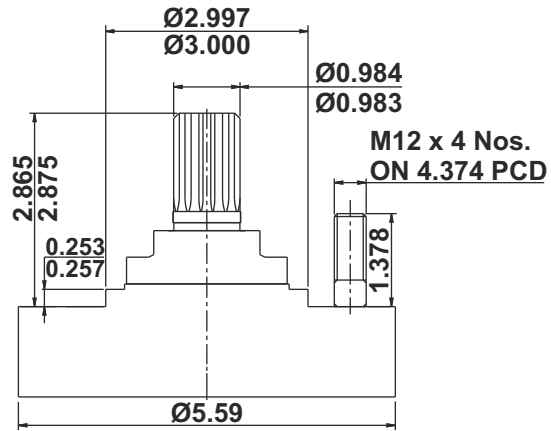

Shaft

Spline shaft: 15 teeth, 16/32 pitch, module 1.5875, 30° pressure angle, coupling tolerance 5 as per ANSI B.92.1, confirming with NEMA 6"

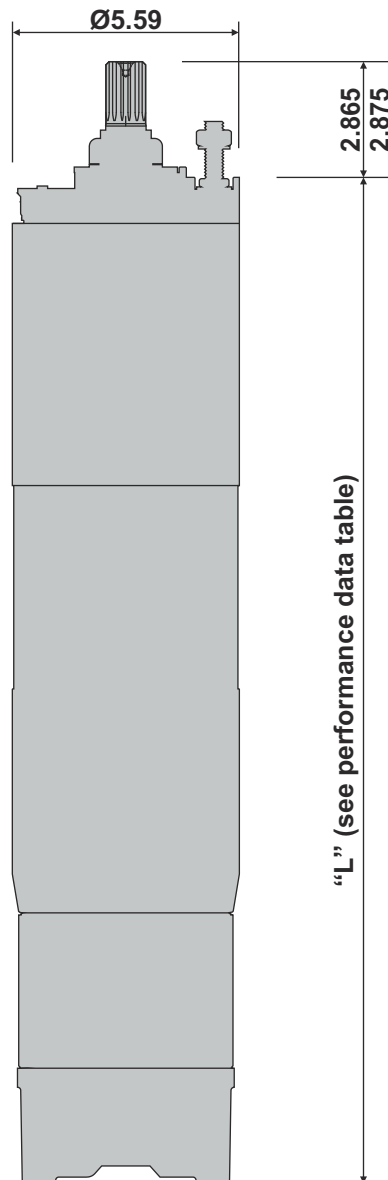

SUBMERSIBLE MOTORS

5 HP to 60 HP

PERFORMANCE DATA-60 Hz

MOTOR SIZE: 6"

P _N [HP]	Phase	S.F	U _N [V]	Thrust Load [N]	n _N [min ⁻¹]	I _N [A]	I _{ST} /I _N [A]	η (Eff.) [%] at % load			Cos φ PF at % load			T _N [Nm]	Length [L] [inch]	Shipping Weight [lbs]
								50	75	100	50	75	100			
5	3	1.15	230	27500	3480	18.5	5.30	69.8	75.8	77.0	0.63	0.74	0.81	10.98	22.36	109
5	3	1.15	460	27500	3500	9.3	4.63	70.3	76.8	78.0	0.66	0.75	0.80	10.92	22.36	109
7½	3	1.15	230	27500	3480	25.8	5.30	74.8	77.8	79.0	0.62	0.74	0.82	15.10	22.95	116
7½	3	1.15	460	27500	3500	12.6	4.72	74.8	77.8	79.0	0.65	0.75	0.82	15.00	22.95	116
10	3	1.15	230	27500	3480	32.6	5.40	75.8	78.8	80.0	0.64	0.76	0.83	20.59	24.13	126
10	3	1.15	460	27500	3500	16.5	5.06	75.8	78.8	80.0	0.66	0.76	0.82	20.47	24.13	126
15	3	1.15	230	27500	3480	46.7	5.60	77.8	80.3	81.0	0.64	0.77	0.84	30.20	27.68	146
15	3	1.15	460	27500	3500	23.3	5.26	77.8	81.3	82.0	0.67	0.77	0.83	30.00	27.68	146
20	3	1.15	230	27500	3480	61.4	5.65	78.3	82.0	83.0	0.64	0.76	0.85	41.18	30.75	172
20	3	1.15	460	27500	3500	31.1	5.38	78.3	81.8	83.0	0.67	0.77	0.84	40.95	30.75	172
25	3	1.15	230	27500	3480	79.4	5.66	78.1	82.9	84.0	0.64	0.77	0.85	50.79	33.50	188
25	3	1.15	460	27500	3500	37.8	5.69	78.3	82.9	84.0	0.68	0.78	0.84	50.50	33.50	188
30	3	1.15	230	27500	3480	92.7	5.60	79.1	83.9	85.0	0.65	0.76	0.85	60.40	39.09	230
30	3	1.15	460	27500	3500	45.0	5.80	78.9	82.9	84.0	0.68	0.78	0.84	60.00	39.09	230
40	3	1.15	230	27500	3480	125.4	5.75	79.9	83.7	85.0	0.67	0.79	0.86	82.37	45.59	281
40	3	1.15	460	27500	3500	60.0	6.19	80.1	83.9	85.0	0.70	0.80	0.85	81.90	45.59	281
50	3	1.15	230	27500	3480	150.4	5.75	80.1	83.9	85.0	0.66	0.79	0.86	101.60	45.87	305
50	3	1.15	460	27500	3500	74.0	5.62	79.9	83.7	85.0	0.69	0.79	0.85	101.00	45.87	305
60	3	1.15	230	27500	3480	177.7	5.77	80.1	83.9	85.0	0.65	0.78	0.86	123.55	48.62	329
60	3	1.15	460	27500	3500	89.9	5.64	79.9	83.7	85.0	0.68	0.78	0.85	122.84	48.62	329
5	1	1.15	230	15500	3500	25.0	6.90	57.0	67.9	74.0	0.73	0.83	0.94	10.10	22.60	126
7½	1	1.15	230	15500	3500	35.0	6.85	58.2	68.9	75.0	0.73	0.84	0.94	15.01	23.10	135
10	1	1.15	230	15500	3500	45.0	6.70	56.1	67.5	76.0	0.75	0.85	0.96	20.47	26.20	146
15	1	1.15	230	15500	3500	63.0	6.75	62.6	72.4	78.0	0.75	0.85	0.96	30.02	29.30	168

SUBMERSIBLE MOTORS

40 HP to 150 HP

GENERAL DATA

MOTOR SIZE: 8"

SUITABLE WELL SIZE

- ▶ These motors are designed and sized for installation in 8" diameter or larger water wells.

FEATURES

- ▶ Heavy duty, rewindable, water filled submersible motor.
- ▶ Stainless steel splined shaft
- ▶ Equipped with Carbon/SiC mechanical shaft seal.
- ▶ Water lubricated heavy duty radial and axial thrust bearings.
- ▶ Counter thrust bearing.
- ▶ Motors are factory-filled with clean water + Glycol mixture.
- ▶ High efficiency electrical design (lower operating cost).
- ▶ Tropicalized design (lower winding temperature).
- ▶ 8" NEMA coupling flange.
- ▶ Pressure compensation diaphragm.



SPECIAL FEATURES ON-REQUEST

- ▶ PT 100 temperature sensor.
- ▶ 50 Hz, voltage and HPs not listed in this catalog.
- ▶ Double cable for Star - Delta operation.
- ▶ PE2/PA winding insulation.

CABLE DATA

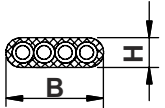
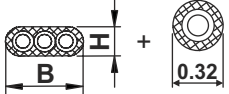
HP	Phase	Type of start	Cable x Lead x Size (AWG)	Length [ft]	H [inch]	B [inch]	
40 - 125	3	DOL	1 x 4 x 6 AWG	16.4	0.55	1.48	
150	3	DOL	1 x 3 x 2 AWG + 1 x 1 x 6 AWG	16.4	0.60	1.38	

SUBMERSIBLE MOTORS

40 HP to 150 HP

GENERAL DATA

MOTOR SIZE: 8"

SPECIFICATIONS

	Motor construction	
	Standard	Premium stainless steel
Frequency	60 Hz	60 Hz
Motor ratings	3 phase - 40 to 150 HP	3 phase - 40 to 150 HP
Voltage (Tolerance +10% / -15%)	3 phase - 230 V, 460 V	3 phase - 230 V, 460 V
Pole/RPM	2 Pole / 3450 RPM	2 Pole / 3450 RPM
Degree of protection	IP 68	IP 68
Duty rating	Continuous	Continuous
Ambient temperature	104 °F / 40 °C	104 °F / 40 °C
Rotation	3 phase - CCW & CW	3 phase - CCW & CW
Maximum nos. of starts/hour	40 to 75 HP - 25 100 to 150 HP - 20	40 to 75 HP - 25 100 to 150 HP - 20
Minimum cooling flow along the motor	40 to 50 HP - 0.5 ft/sec 60 to 150 HP - 1 ft/sec	40 to 50 HP - 0.5 ft/sec 60 to 150 HP - 1 ft/sec
Maximum submerged depth	656 feet / 200 metres	656 feet / 200 metres
Mounting	Vertical	Vertical

NOTE: SPECIFICATIONS ARE SUBJECT TO PERIODIC CHANGES DUE TO CONTINUOUS IMPROVEMENTS.

STANDARD SUBMERSIBLE MOTORS

40 HP to 150 HP MATERIAL OF CONSTRUCTION MOTOR SIZE: 8"

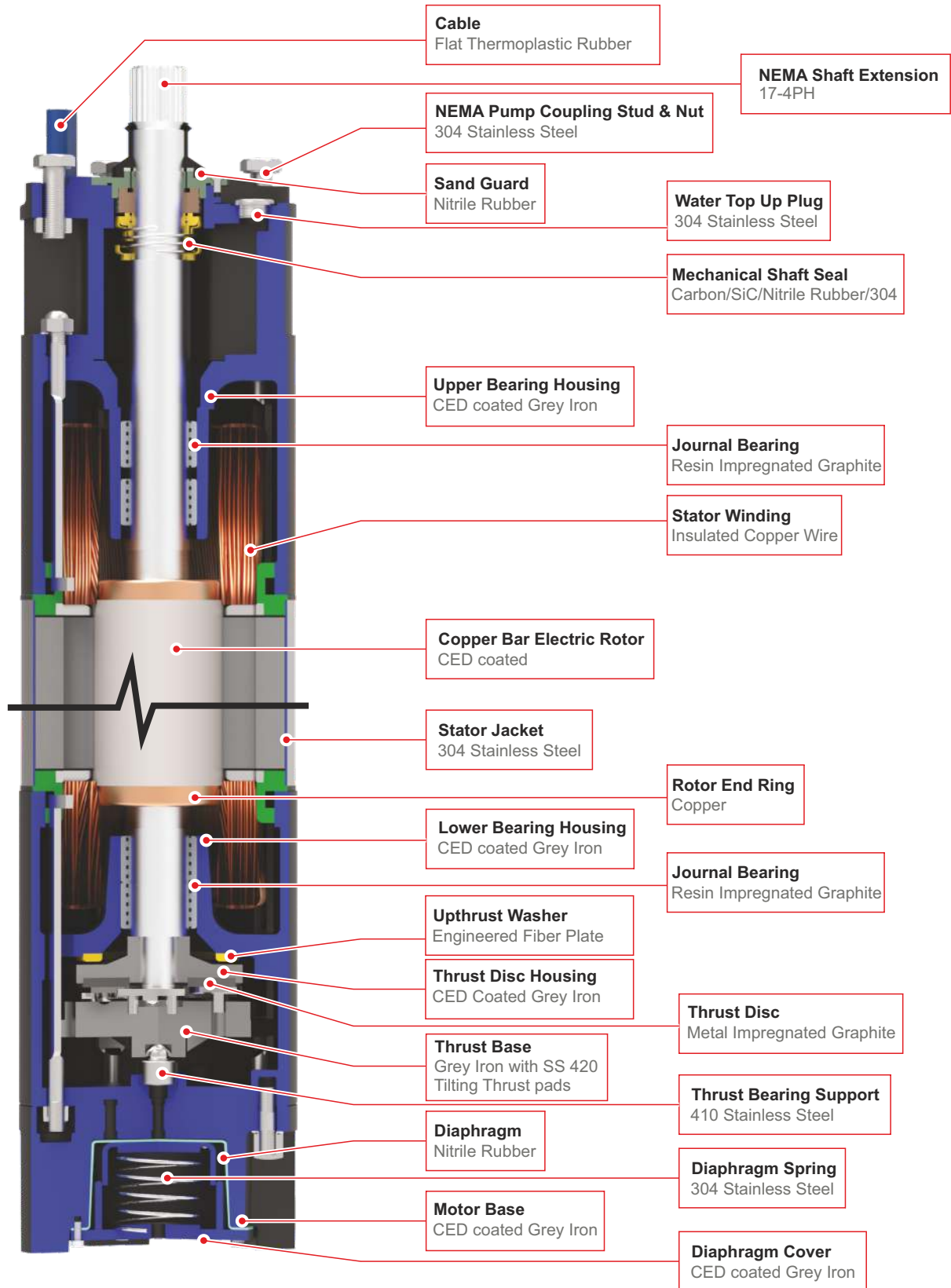

PREMIUM STAINLESS STEEL SUBMERSIBLE MOTORS

40 HP to 150 HP MATERIAL OF CONSTRUCTION MOTOR SIZE: 8"

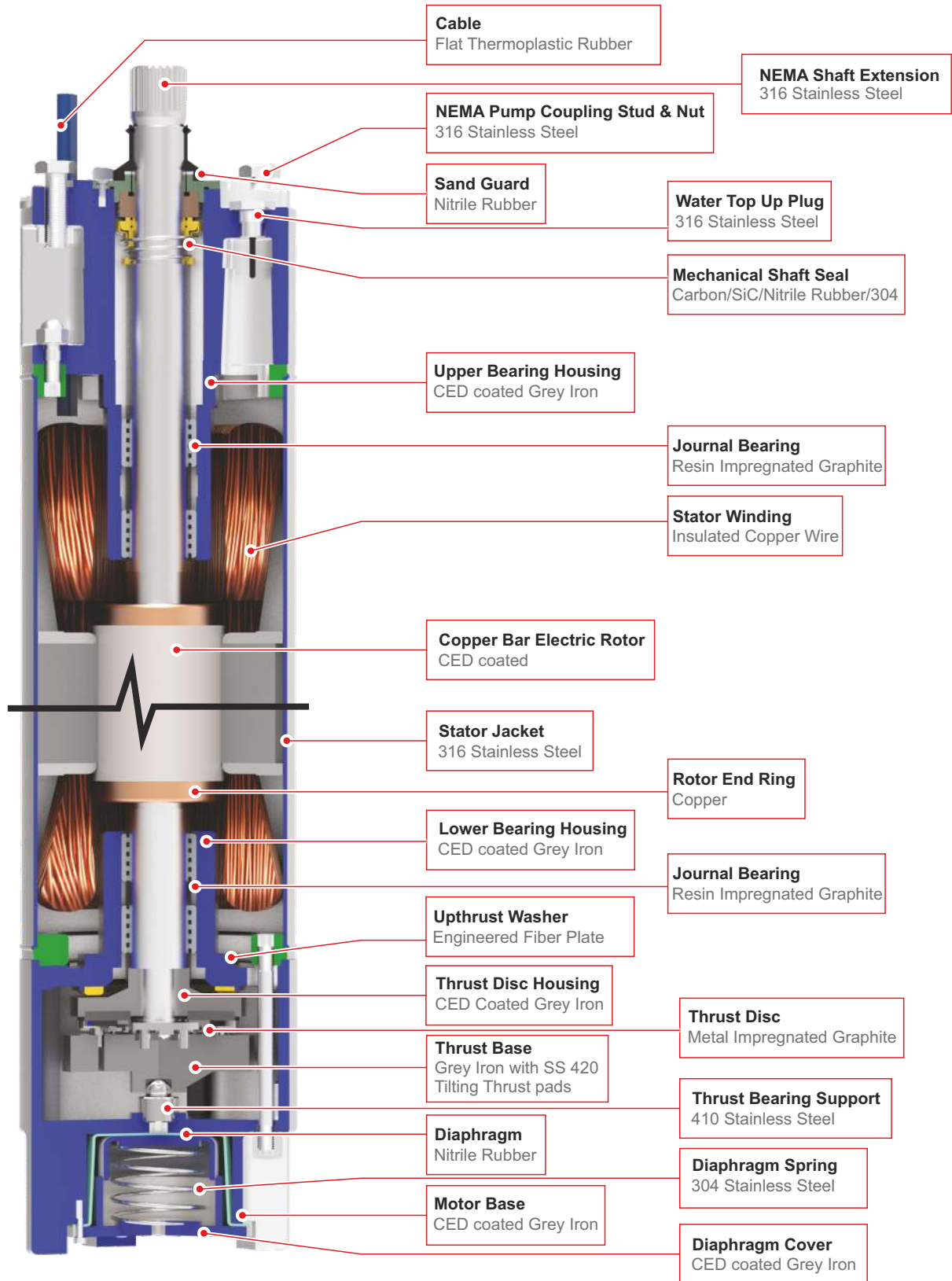

SUBMERSIBLE MOTORS

40 HP to 150 HP

ORDER INFORMATION

MOTOR SIZE: 8"

HP	Hz	PHASE	VOLTS	POLE	MOTOR SIZE	ORDER NO. / MODEL CODE	
						STANDARD	PREMIUM STAINLESS STEEL
40	60	3	230	2	8"	NM-C-8-0400-6-3-B-2	NM-B-8-0400-6-3-B-2
	60	3	460	2	8"	NM-C-8-0400-6-3-D-2	NM-B-8-0400-6-3-D-2
50	60	3	230	2	8"	NM-C-8-0500-6-3-B-2	NM-B-8-0500-6-3-B-2
	60	3	460	2	8"	NM-C-8-0500-6-3-D-2	NM-B-8-0500-6-3-D-2
60	60	3	230	2	8"	NM-C-8-0600-6-3-B-2	NM-B-8-0600-6-3-B-2
	60	3	460	2	8"	NM-C-8-0600-6-3-D-2	NM-B-8-0600-6-3-D-2
75	60	3	230	2	8"	NM-C-8-0750-6-3-B-2	NM-B-8-0750-6-3-B-2
	60	3	460	2	8"	NM-C-8-0750-6-3-D-2	NM-B-8-0750-6-3-D-2
100	60	3	230	2	8"	NM-C-8-1000-6-3-B-2	NM-B-8-1000-6-3-B-2
	60	3	460	2	8"	NM-C-8-1000-6-3-D-2	NM-B-8-1000-6-3-D-2
125	60	3	230	2	8"	NM-C-8-1250-6-3-B-2	NM-B-8-1250-6-3-B-2
	60	3	460	2	8"	NM-C-8-1250-6-3-D-2	NM-B-8-1250-6-3-D-2
150	60	3	230	2	8"	NM-C-8-1500-6-3-B-2	NM-B-8-1500-6-3-B-2
	60	3	460	2	8"	NM-C-8-1500-6-3-D-2	NM-B-8-1500-6-3-D-2

SUBMERSIBLE MOTORS

40 HP to 150 HP

DIMENSIONS

MOTOR SIZE: 8"

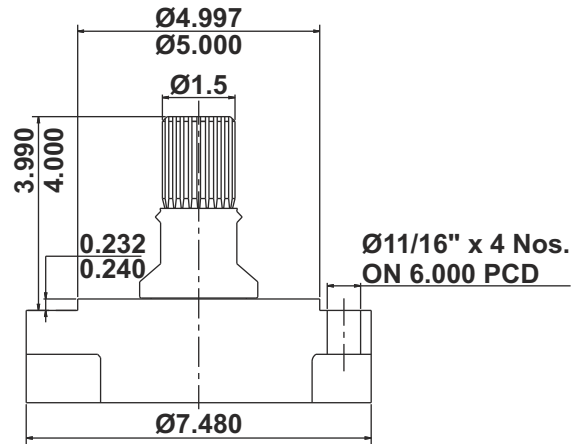

Shaft

Spline shaft: 23 teeth, 16/32 pitch, module 1.5875, 30° pressure angle, coupling tolerance 5 as per ANSI B.92.1, confirming with NEMA 8"

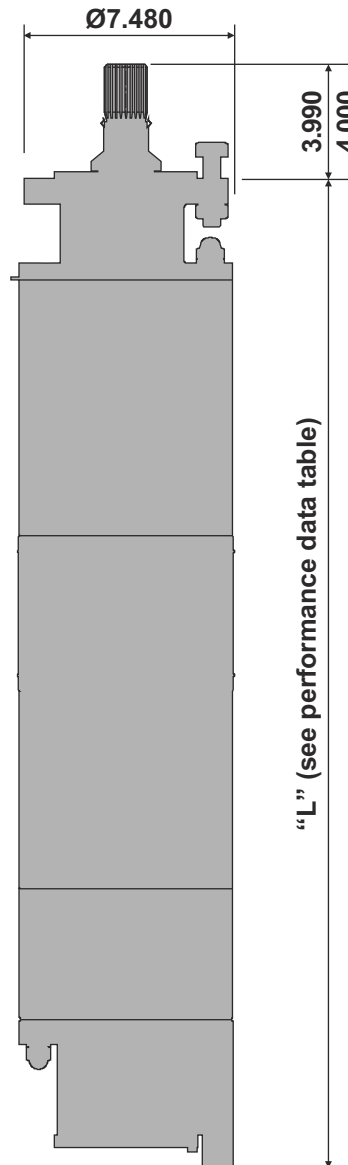

SUBMERSIBLE MOTORS

40 HP to 150 HP

PERFORMANCE DATA-60 Hz

MOTOR SIZE: 8"

P _N [HP]	Phase	S.F	U _N [V]	Thrust Load [N]	n _N [min ⁻¹]	I _N [A]	I _{ST} /I _N [A]	η (Eff.) [%] at % load			Cos φ PF at % load			T _N [Nm]	Length [L] [inch]	Shipping Weight [lbs]
								50	75	100	50	75	100			
40	3	1.15	460	45000	3480	57.2	5.8	82.1	84.3	85.0	0.78	0.84	0.89	82.4	44.90	394
50	3	1.15	230	45000	3480	149.6	5.8	82.1	83.9	85.0	0.75	0.81	0.84	101.6	48.44	431
50	3	1.15	460	45000	3480	72.2	5.8	82.1	84.5	85.0	0.77	0.84	0.87	101.6	48.44	431
60	3	1.15	230	45000	3500	179.8	5.8	83.1	84.9	86.0	0.75	0.81	0.84	122.9	52.38	473
60	3	1.15	460	45000	3500	86.5	5.8	83.3	85.5	86.3	0.76	0.82	0.87	122.9	52.38	473
75	3	1.15	230	45000	3500	217.3	5.8	83.2	85.3	87.0	0.75	0.80	0.84	150.0	54.35	506
75	3	1.15	460	45000	3500	104.9	5.8	83.7	85.9	87.0	0.76	0.82	0.87	150.0	54.35	506
100	3	1.15	230	45000	3500	286.1	5.8	83.5	85.9	88.0	0.75	0.82	0.86	204.7	59.78	568
100	3	1.15	460	45000	3500	139.8	6.0	84.2	86.9	88.0	0.77	0.83	0.88	204.7	59.78	568
125	3	1.15	230	45000	3500	363.2	5.8	83.7	85.7	88.0	0.75	0.81	0.84	253.8	65.30	634
125	3	1.15	460	45000	3500	174.7	6.0	84.5	86.9	88.3	0.76	0.82	0.87	253.8	65.30	634
150	3	1.15	460	45000	3480	214.0	6.0	82.4	84.9	86.2	0.76	0.82	0.86	302.0	70.41	735

SUBMERSIBLE MOTORS

150 HP to 250 HP

GENERAL DATA

MOTOR SIZE: 10"

SUITABLE WELL SIZE

- ▶ These motors are designed and sized for installation in 10" diameter or larger water wells.

FEATURES

- ▶ Heavy duty, rewindable, water filled submersible motor.
- ▶ PE insulated windings.
- ▶ Stainless steel splined shaft.
- ▶ Equipped with Carbon/SiC mechanical shaft seal.
- ▶ Water lubricated heavy duty radial and axial thrust bearings.
- ▶ Counter thrust bearing.
- ▶ Motors are factory-filled with clean water + Glycol mixture.
- ▶ High efficiency electrical design (lower operating cost).
- ▶ Tropicalized design (lower winding temperature).
- ▶ 10" NEMA coupling flange.
- ▶ Pressure compensation diaphragm.



SPECIAL FEATURES ON-REQUEST

- ▶ PT 100 temperature sensor.
- ▶ 50 Hz, voltage and HPs not listed in this catalog.
- ▶ Double cable for Star - Delta operation.
- ▶ PE2/PA winding insulation.

CABLE DATA

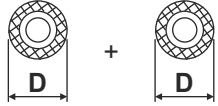
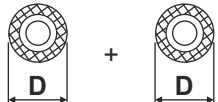
HP	Phase	Type of start	Cable x Lead x Size (AWG)	Length [ft]	D [inch]	
150 - 250	3	DOL	3 x 1 x 00 AWG + 1 x 1 x 0 AWG	16.4	0.55 + 0.55	
150 - 250	3	YΔ	6 x 1 x 2 AWG + 1 x 1 x 6 AWG	16.4	0.55 + 0.28	

SUBMERSIBLE MOTORS

150 HP to 250 HP

GENERAL DATA

MOTOR SIZE: 10"

SPECIFICATIONS

	Motor construction	
	Standard	Premium stainless steel
Frequency	60 Hz	60 Hz
Motor ratings	3 phase, 150 to 250 HP	3 phase, 150 to 250 HP
Voltage (Tolerance +10% / -15%)	230 V, 460 V	230 V, 460 V
Pole/RPM	2 Pole / 3450 RPM	2 Pole / 3450 RPM
Degree of protection	IP 68	IP 68
Duty rating	Continuous	Continuous
Ambient temperature	104 °F / 40 °C	104 °F / 40 °C
Rotation	3 phase, CCW & CW	3 phase, CCW & CW
Maximum nos. of starts/hour	150 HP - 20 175 to 250 HP - 15	150 HP - 20 175 to 250 HP - 15
Minimum cooling flow along the motor	150 to 250 HP - 1.6 ft/sec	150 to 250 HP - 1.6 ft/sec
Maximum submerged depth	656 feet / 200 metres	656 feet / 200 metres
Mounting	Vertical	Vertical

NOTE: SPECIFICATIONS ARE SUBJECT TO PERIODIC CHANGES DUE TO CONTINUOUS IMPROVEMENTS.

STANDARD SUBMERSIBLE MOTORS

150 HP to 250 HP MATERIAL OF CONSTRUCTION MOTOR SIZE: 10"

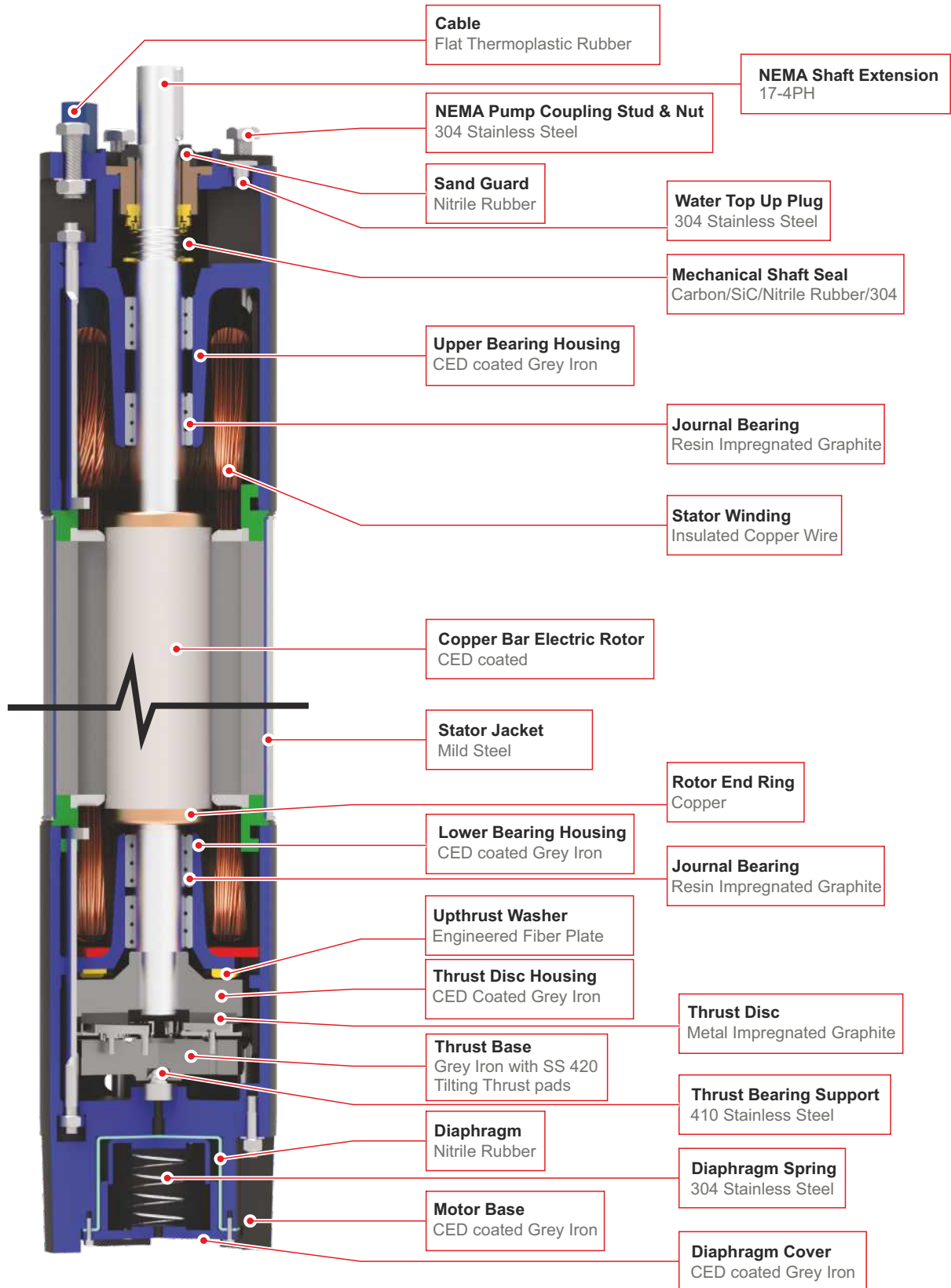

SUBMERSIBLE MOTORS

150 HP to 250 HP

ORDER INFORMATION

MOTOR SIZE: 10"

HP	Hz	PHASE	VOLTS	POLE	MOTOR SIZE	ORDER NO. / MODEL CODE	
						STANDARD	PREMIUM STAINLESS STEEL
150	60	3	460	2	10"	NM-C-1-1500-6-3-D-2	NM-B-1-1500-6-3-D-2
175	60	3	460	2	10"	NM-C-1-1750-6-3-D-2	NM-B-1-1750-6-3-D-2
200	60	3	460	2	10"	NM-C-1-2000-6-3-D-2	NM-B-1-2000-6-3-D-2
250	60	3	460	2	10"	NM-C-1-2500-6-3-D-2	NM-B-1-2500-6-3-D-2

SUBMERSIBLE MOTORS

150 HP to 250 HP

DIMENSIONS

MOTOR SIZE: 10"

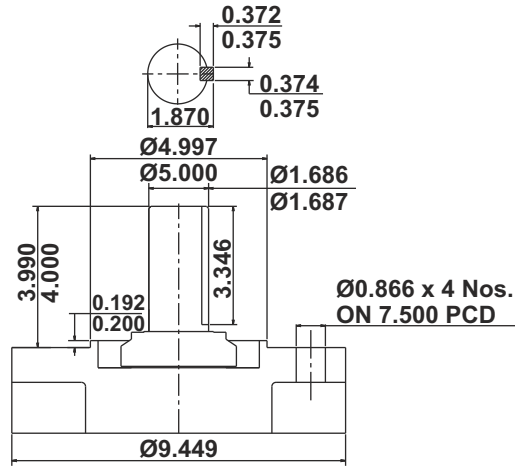

Shaft
Cylindrical shaft with key

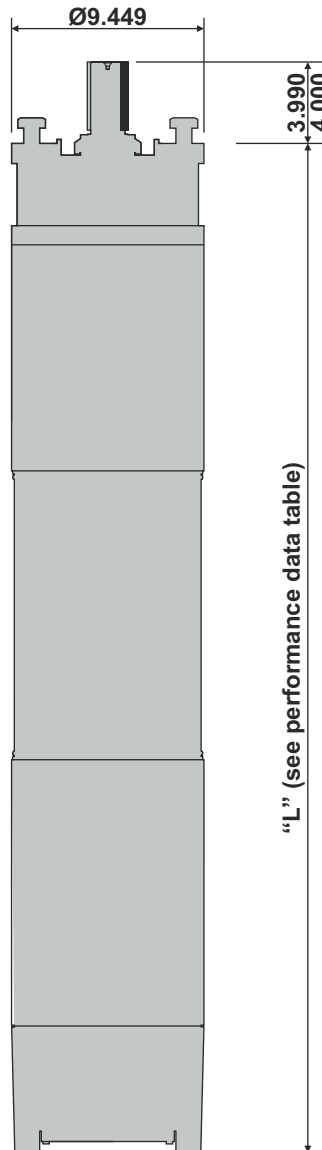

SUBMERSIBLE MOTORS

150 HP to 250 HP

PERFORMANCE DATA-60 Hz

MOTOR SIZE: 10"

P _N [HP]	Phase	S.F	U _N [V]	Thrust Load [N]	n _N [min ⁻¹]	I _N [A]	I _{ST} /I _N [A]	η (Eff.) [%] at % load			Cos φ PF at % load			T _N [Nm]	Length [L] [inch]	Shipping Weight [lbs]
								50	75	100	50	75	100			
150	3	1.15	460	60000	3500	224.5	5.16	84.1	86.1	86.0	0.70	0.79	0.84	300.2	69.61	1056
175	3	1.15	460	60000	3500	253.5	5.15	85.1	87.1	87.0	0.76	0.83	0.87	368.5	73.48	1144
200	3	1.15	460	60000	3500	293.5	5.30	85.1	87.1	87.0	0.76	0.83	0.87	409.5	78.60	1214
250	3	1.15	460	60000	3500	376.0	5.64	85.1	87.1	87.0	0.69	0.78	0.84	505.0	82.54	1324

Limited Warranty for Deep Well Submersible Products

Northam Inc. offers limited Warranty on its Deep Well Submersible Products to be free from any defects in material or workmanship under normal intended use for the period as shown below.

Our Warranty shall not apply to any product that has been;

1. Subjected to misuse or misapplication.
2. Altered or modified without authorization from Northam Inc. or failure to use Northam Original Replacement Parts.
3. Improperly installed or installed with improper controls and protection against power irregularities.
4. Subjected to Dry Run or full Flow Shut Off condition.
5. Operated in liquids other than Potable Water.
6. Operated in liquid temperature higher than 86 degrees Fahrenheit.
7. Pumps which are clogged with mud, sand, gravel or any other foreign material.
8. Damaged due to accidental damage, fire, acts of God, or any other circumstances outside the control of Northam.
9. Repaired by persons who are not authorized by Northam.

This warranty does not cover normal wear and tear of products or parts thereof. It also does not cover change in performance of products due to normal wear and tear.

Northam Inc. shall not be responsible for removing or reinstallation of the products covered under this warranty nor shall be responsible for any charges associated with removal and reinstallation.

Northam Inc.'s obligation under this Warranty is limited to either repair or replace the product at Northam's sole discretion for any product found to Northam's reasonable satisfaction to have been found defective upon examination by Northam. The product shall have to be returned to Northam Inc.'s Clarks Summit facility or any other place that Northam Inc. shall designate within 30 days of failure for evaluation.

Northam is not responsible under this warranty for any cost of shipping or transportation of the product or parts thereof to or from Northam facility or any other place that Northam shall designate for product to be sent for evaluation or repairs.

This warranty is applicable only if the product is received by Northam Inc. without any damage during shipment back to Northam Inc. It does not cover products that are lost or cannot be returned to Northam Inc.

Northam Inc. does not warrant any parts or products that were not manufactured by them. Northam shall extend the warranty provided by the manufacturer of such parts or products under such circumstances.

Northam Inc. shall not cover drop cables, lead wires, control boxes or any accessories under Warranty.

This Warranty applies to products sold only in USA.

Northam Inc. shall not be liable for any consequential, incidental, or contingent damages or loss to persons or property whatsoever. The foregoing warranties are exclusive and in lieu of any written or implied warranties including but not limited to the implied warranties of merchantability or fitness for a particular purpose covering any product manufactured by Northam Inc. Some states do not allow the exclusion or limitation of incidental or consequential damages so the above may not apply to you. Also some states do not allow a limitation on how long an implied warranty will last so the above limitation may not apply to you and during the period of this limited warranty any implied warranties of merchantability or fitness for particular purpose may not be excluded.

Limited Warranty Period for Deep well Submersible Products

4", 6", 8", 10 " Submersible Pumps or Motors or Complete Units.

Northam shall offer Limited warranty of above mentioned products for a period of 12 months from the date of installation or 18 months from the date of dispatch from Northam Inc. whichever comes first. The warranty shall cover only mechanical defects in material and workmanship.

Warranty Service

For products purchased directly from Northam kindly e mail to service@northam-inc.com with the following information. For Northam products purchased from our Authorised Dealers/Distributors kindly contact them directly with the following information.

1. Invoice number.
2. Date of purchase.
3. Product Type or Model number available on the name plate.
4. Product Serial number from the nameplate
5. Description of Defect with the product.
6. Your contact telephone number and address.

Once Northam will receive the above information, they shall promptly provide by return email a "Return Authorisation Form" and address to which the product shall be shipped by customer for evaluation of manufacturing defect by Northam. The customer shall then ship the product, freight prepaid to the address indicated, together with a Return Authorisation Form obtained from Northam. Unauthorised Returns and products sent without prepaid freight will not be accepted by Northam.

Once Product is received at Northam it shall be evaluated by Technical Service at Northam for any manufacturing defect and the customer shall be notified of the final outcome and any corrections that Northam shall be initiating if a manufacturing defect is found. Once a repaired or replacement product is ready it shall be shipped to the customer with freight charges to be paid by the customer.



Northam Inc.

995/C Griffin Pond Road, Clarks Summit, PA 18411, USA
Phone : +1-570-659-7200, Email : sales@northam-inc.com