

NM SERIES

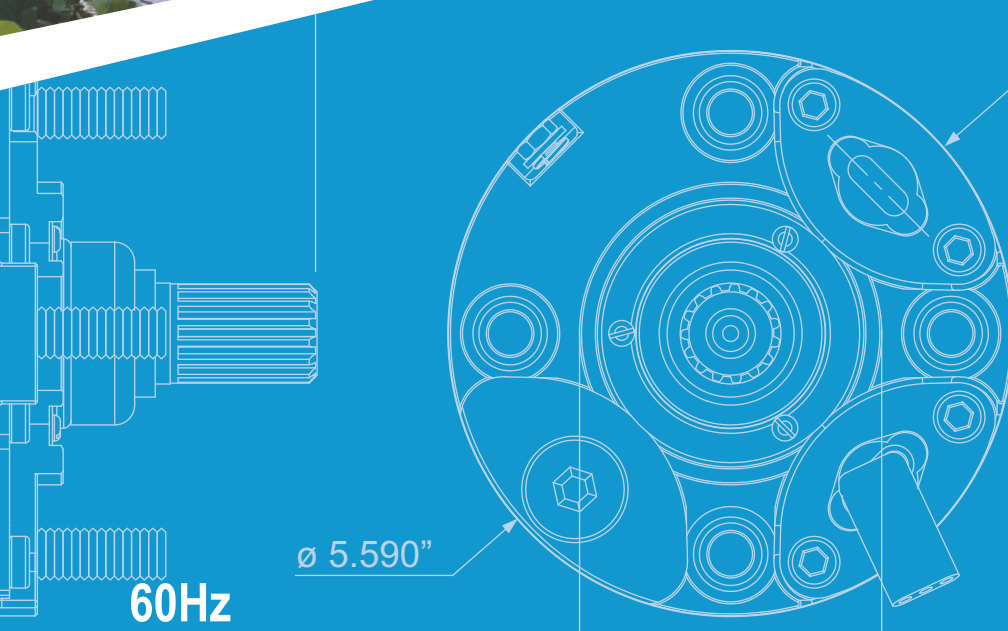

**WATER FILLED
SUBMERSIBLE
MOTORS**

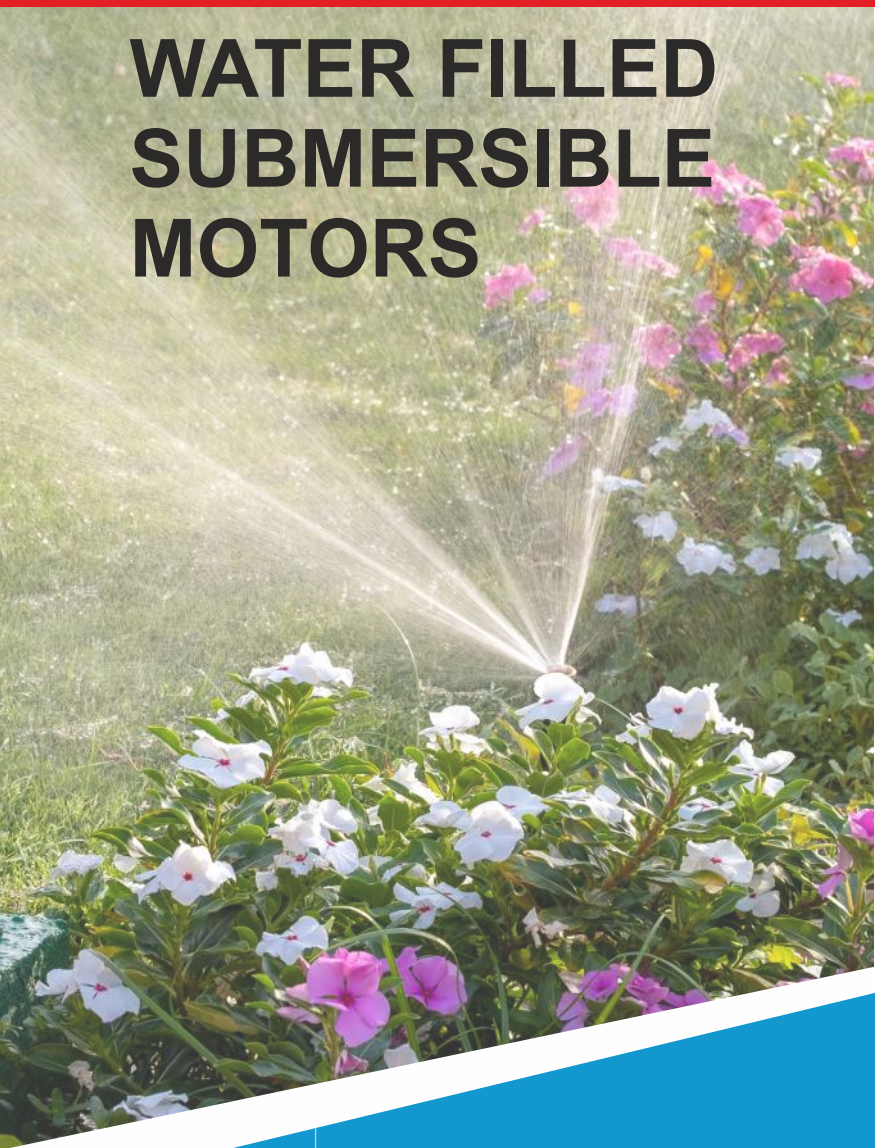

PRODUCT CATALOGUE

www.northam-inc.com

SUBMERSIBLE MOTORS

CONTENTS

Model Code	3
4" F4 Water Filled Motors	
General Data	4
Material of Construction	5
Order Information	6
Dimensions	7
Performance Data	9
Control Box Model Code	11
Control Box Standard	12
Control Box Dimensions	13

SUBMERSIBLE MOTORS

0.5 HP to 7.5 HP MODEL CODE MOTOR SIZE: 4"

NM
A
4
0005
6
2W
A
2
2

Thrust Load

Code	Thrust Load
2	2000N
3	3000N
4	4000N
6	6000N

Pole

Code	Pole
2	2

Volts

Code	Volts
A	110-115V
B	220-230V
D	460V

Power Supply

Code	Power Supply
2W	2-wire single phase
3W	3-wire single phase
3P	3 Phase

Frequency

Code	Hz
6	60

Motor HP

Code	HP
0005	0.5 HP
0007	0.75 HP
0010	1 HP
0075	7.5 HP

Motor size

Code	Size
4	4"

Material of construction

Code	Material
A	304 Stainless steel
B	316 Stainless steel
C	304 Stainless steel over iron

Series name

Code	Series
NM	F4 Water Filled Motors

SUBMERSIBLE MOTORS

0.5 HP to 7.5 HP

GENERAL DATA

MOTOR SIZE: 4"

SUITABLE WELL SIZE

- ▶ These motors are designed and sized for installation in 4" diameter or larger water wells.

FEATURES

- ▶ Heavy duty, rewindable, water filled submersible motor.
- ▶ Stainless steel splined shaft
- ▶ Equipped with Carbon/SiC mechanical shaft seal.
- ▶ Water lubricated heavy duty radial and axial thrust bearings.
- ▶ Counter thrust bearing.
- ▶ Motors are factory-filled with clean water + Glycol mixture.
- ▶ High efficiency electrical design (lower operating cost).
- ▶ Tropicalized design (lower winding temperature).
- ▶ 4" NEMA coupling flange.
- ▶ Pressure compensation diaphragm.



SPECIFICATIONS

	Motor construction
	Standard + High Thrust
Frequency	60 Hz
Motor ratings	3 phase - 1.5 to 7.5 HP 1 phase - 0.5 to 5.0 HP
Voltage (Tolerance +10% / -15%)	3 phase - 460 V 1 phase - 230 V
Pole/RPM	2 Pole / 3450 RPM
Degree of protection	IP 68
Duty rating	Continuous
Ambient temperature	113 °F / 45 °C
Rotation	3 phase - CCW 1 phase - CCW
Maximum nos. of starts/hour	0.5 to 3.0 HP - 20 5 to 7.5 HP - 10
Minimum cooling flow along the motor	0.5 to 7.5 HP = 8 - 0.25 ft/sec
Maximum submerged depth	820 feet / 350 metres
Mounting	Vertical

NOTE: SPECIFICATIONS ARE SUBJECT TO PERIODIC CHANGES DUE TO CONTINUOUS IMPROVEMENTS.

4" STANDARD SUBMERSIBLE MOTOR

0.5 HP to 7.5 HP

Material of Construction

MOTOR SIZE: 4"

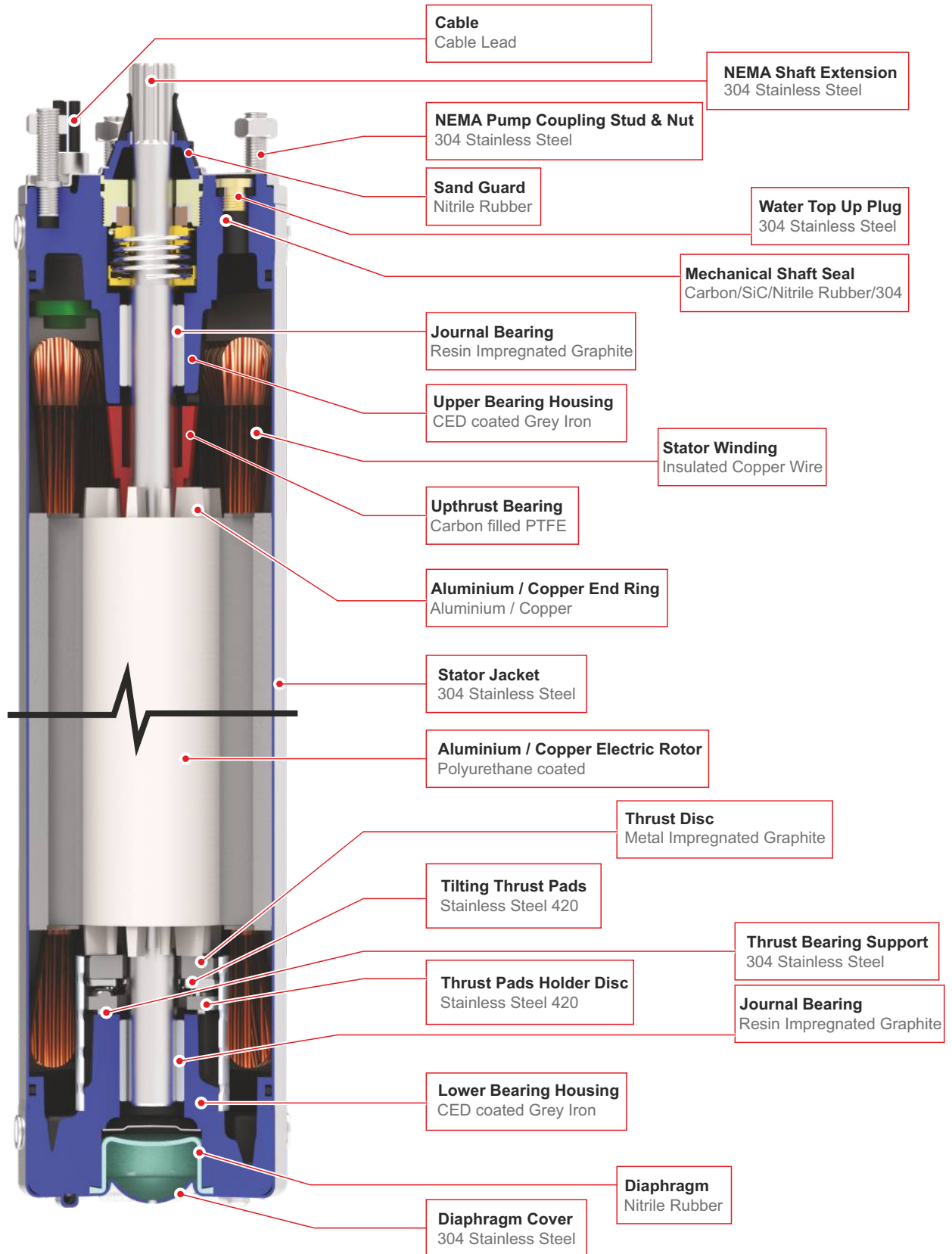

4" HIGH THRUST SUBMERSIBLE MOTOR

0.5 HP to 7.5 HP Material of Construction MOTOR SIZE: 4"

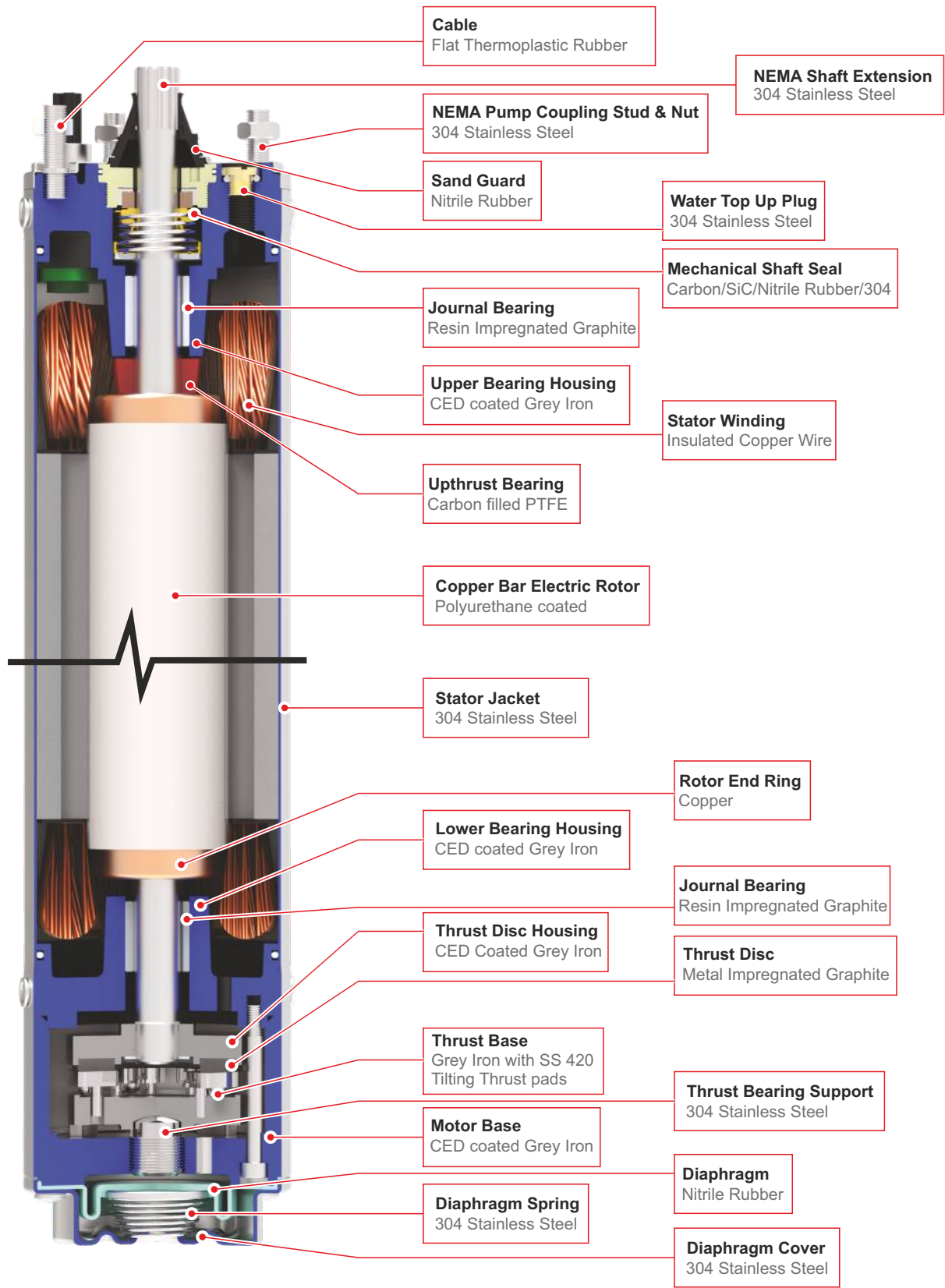

4" SUBMERSIBLE MOTOR

0.5 HP to 7.5 HP

ORDER INFORMATION

MOTOR SIZE: 4"

SINGLE PHASE

HP	kW	Hz	WIRE	VOLTS	CABLE (ft)	Thrust Load [N]	Motor Type	ORDER NO. / MODEL CODE
0.5	0.37	60	2	220-230	3.9	1500N	Permanent Split Capacitor	NM-C-4-0005-6-2W-B-2-2
0.75	0.55	60	2	220-230	3.9	1500N		NM-C-4-0007-6-2W-B-2-2
1.0	0.75	60	2	220-230	3.9	3000N		NM-C-4-0010-6-2W-B-2-3
1.5	1.1	60	2	220-230	3.9	3000N		NM-C-4-0015-6-2W-B-2-3
0.5	0.37	60	3	220-230	3.9	1500N	Capacitor Start & Run	NM-C-4-0005-6-3W-B-2-2
0.75	0.55	60	3	220-230	3.9	1500N		NM-C-4-0007-6-3W-B-2-2
1.0	0.75	60	3	220-230	3.9	3000N		NM-C-4-0010-6-3W-B-2-3
1.5	1.1	60	3	220-230	3.9	3000N		NM-C-4-0015-6-3W-B-2-3
2.0	1.5	60	3	220-230	3.9	3000N		NM-C-4-0020-6-3W-B-2-3
3.0	2.2	60	3	220-230	8.2	3000N		NM-C-4-0030-6-3W-B-2-4
5.0	3.7	60	3	220-230	8.2	3000N		NM-C-4-0050-6-3W-B-2-6

THREE PHASE

HP	kW	Hz	VOLTS	CABLE (ft)	Thrust Load [N]	ORDER NO. / MODEL CODE
1.5	1.1	60	220-230	3.9	3000N	NM-C-4-0015-6-3P-B-2-3
2.0	1.5	60	220-230	3.9	3000N	NM-C-4-0020-6-3P-B-2-3
3.0	2.2	60	220-230	8.2	4000N	NM-C-4-0030-6-3P-B-2-4
5.0	3.7	60	220-230	8.2	6000N	NM-C-4-0050-6-3P-B-2-6
7.5	5.5	60	220-230	8.2	6000N	NM-C-4-0075-6-3P-B-2-6
1.5	1.1	60	460	3.9	3000N	NM-C-4-0015-6-3P-D-2-3
2.0	1.5	60	460	3.9	3000N	NM-C-4-0020-6-3P-D-2-3
3.0	2.2	60	460	8.2	4000N	NM-C-4-0030-6-3P-D-2-4
5.0	3.7	60	460	8.2	6000N	NM-C-4-0050-6-3P-D-2-6
7.5	5.5	60	460	8.2	6000N	NM-C-4-0075-6-3P-D-2-6

SUBMERSIBLE MOTORS

0.5 HP to 7.5 HP

DIMENSIONS

MOTOR SIZE: 4"

2-wire

HP	VOLTS	Dimension H (in)	Cable (ft)	Cable (AWG)	Shipping Weight (lbs)
0.5	230	19	3.9	14	23
0.75	230	20	3.9	14	28
1.0	230	21	3.9	14	31
1.5	230	23	3.9	14	35

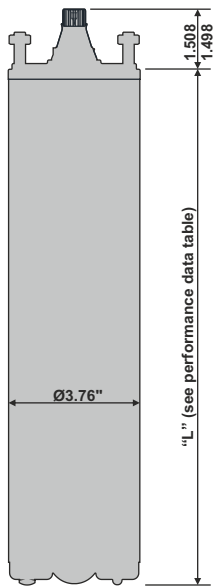
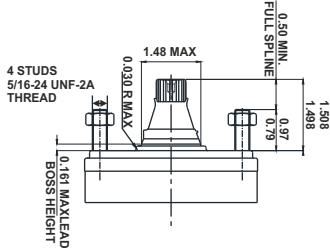

3-wire

HP	VOLTS	Dimension H (in)	Cable (ft)	Cable (AWG)	Shipping Weight (lbs)
0.5	230	12.3	3.9	14	18.5
0.75	230	13.3	3.9	14	24.6
1.0	230	14.3	3.9	14	27.1
1.5	230	16.2	3.9	14	31.7
2.0	230	18.2	3.9	14	35.9
3.0	230	22.3	8.2	14	48.6
5.0	230	30.2	8.2	14	69.1

SUBMERSIBLE MOTORS

0.5 HP to 7.5 HP

DIMENSIONS

MOTOR SIZE: 4"

Three Phase

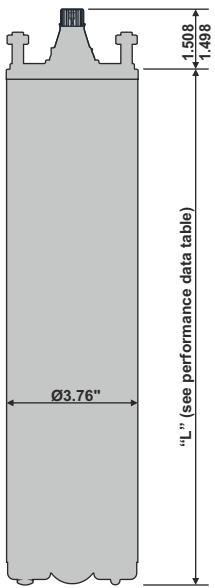
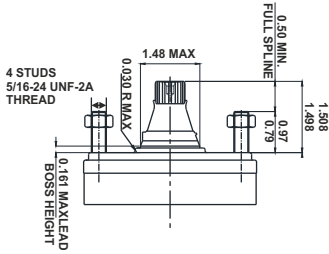

HP	VOLTS	Dimension H (in)	Cable (ft)	Cable (AWG)	Shipping Weight (lbs)
1.5	230	19.9	3.9	14	39.4
2.0	230	21.1	3.9	14	45.5
3.0	230	22.2	8.2	14	54.3
5.0	230	28.1	8.2	14	72.4
7.5	230	32.2	8.2	14	73.5

HP	VOLTS	Dimension H (in)	Cable (ft)	Cable (AWG)	Shipping Weight (lbs)
1.5	460	19.9	3.9	14	39.4
2.0	460	21.1	3.9	14	45.5
3.0	460	22.2	8.2	14	54.3
5.0	460	28.1	8.2	14	72.4
7.5	460	32.2	8.2	14	73.5

SUBMERSIBLE MOTORS

Single Phase

PERFORMANCE DATA-60 Hz

MOTOR SIZE: 4"

2-wire

P _N [HP]	S.F	U _N [V]	Thrust Load [N]	n _N [min ⁻¹]	Full Load			Service Factor Load			Locked Rotor Amp	KVA code
					Amp	Eff. %	Power Factor	Amp	Eff. %	Power Factor		
½	1.60	230	1500	3450	3.74	50.4	0.94	4.95	51.4	0.95	15	H
¾	1.50	230	1500	3450	4.73	59	0.95	7.48	55.0	0.95	22	H
1	1.40	230	3000	3450	6.38	60.5	0.93	8.58	62.0	0.95	27	G
1½	1.30	230	3000	3450	10.56	65.2	0.77	12.1	67.7	0.84	46	H

3-wire

P _N [HP]	S.F	U _N [V]	Thrust Load [N]	n _N [min ⁻¹]	Full Load			Service Factor Load			Locked Rotor Amp	KVA code
					Amp	Eff. %	Power Factor	Amp	Eff. %	Power Factor		
½	1.60	230	1500	3450	3.74	50.4	0.94	4.95	51.4	0.95	15	H
¾	1.50	230	1500	3450	4.73	59	0.95	7.48	55.0	0.95	22	H
1	1.40	230	3000	3450	6.38	60.5	0.93	8.58	62.0	0.95	27	G
1½	1.30	230	3000	3450	10.56	65.2	0.77	12.1	67.7	0.84	46	H
2	1.25	230	3000	3450	12.43	68	0.85	14.96	67.0	0.89	56	H
3	1.15	230	3000	3450	13.4	73	0.98	17.49	71.0	0.98	56	D
5	1.15	230	3000	3450	25.3	72	0.99	29.7	70.0	0.98	92	D

SUBMERSIBLE MOTORS

Three Phase

PERFORMANCE DATA-60 Hz

MOTOR SIZE: 4"

P _N [HP]	S.F	U _N [V]	Thrust Load [N]	n _N [min ⁻¹]	Full Load			Service Factor Load			Locked Rotor Amp	KVA code
					Amp	Eff. %	Power Factor	Amp	Eff. %	Power Factor		
1½	1.30	230	3000	3450	6.16	69	0.71	7.04	71	0.78	38	G
2	1.25	230	3000	3450	7.7	70	0.77	8.8	71	0.82	40	E
3	1.15	230	4000	3450	11.22	72	0.74	12.1	73	0.78	54	D
5	1.15	230	6000	3450	16.5	76	0.8	18.92	76	0.82	88	D
7½	1.15	230	6000	3450	24.64	78	0.79	27.72	77	0.82	120	C

P _N [HP]	S.F	U _N [V]	Thrust Load [N]	n _N [min ⁻¹]	Full Load			Service Factor Load			Locked Rotor Amp	KVA code
					Amp	Eff. %	Power Factor	Amp	Eff. %	Power Factor		
1½	1.30	460	3000	3450	3.08	69	0.71	3.52	71	0.78	19	G
2	1.25	460	3000	3450	3.85	70	0.77	4.4	71	0.82	20	E
3	1.15	460	4000	3450	5.61	72	0.74	6.05	73	0.78	27	D
5	1.15	460	6000	3450	8.25	76	0.8	9.46	76	0.82	44	D
7½	1.15	460	6000	3450	12.32	78	0.79	13.86	77	0.82	60	C

CONTROL BOX

0.5 HP to 5 HP MODEL CODE MOTOR SIZE: 4"

NB **W** **4** **S** **0005** **A**

Volts

Code	Volts
A	110-115V
B	220-230V

Motor HP

Code	HP
0005	0.5 HP
0007	0.75 HP
0010	1 HP
0050	5 HP

Capacitor Type

Code	Capacitor Type
S	Start capacitor
D	Start & Run capacitor

Motor size

Code	Size
4	4"

Submersible Motor Type

Code	Submersible Motor Type
W	Water Filled Submersible Motors

Series name

Code	Series
NB	Control box

CONTROL BOX

Single Phase

ORDER INFORMATION

MOTOR SIZE: 4"

Model	Capacitor Type	HP	Voltage [V]	Start Capacitor MFD	Run Capacitor UF
NB-W-4-D-0005-B	START & RUN	0.5	220-230	60 - 80 MFD 400V	15UF 440V
NB-W-4-D-0007-B	START & RUN	0.75	220-230	120 - 150 MFD 400V	20UF 440V
NB-W-4-D-0010-B	START & RUN	1.0	220-230	100 - 120 MFD 400V	25UF 440V
NB-W-4-D-0015-B	START & RUN	1.5	220-230	150 - 200 MFD 400V	20UF 440V
NB-W-4-D-0020-B	START & RUN	2.0	220-230	200 - 250 MFD 400V	30UF 440V
NB-W-4-D-0030-B	START & RUN	3.0	220-230	200 - 250 MFD 400V	60UF 440V
NB-W-4-D-0050-B	START & RUN	5.0	220-230	250 - 300 MFD 400V	72UF 440V

CONTROL BOX

Single Phase

DIMENSIONS

MOTOR SIZE: 4"

Start Capacitor Control box

Start & Run Capacitor Control box

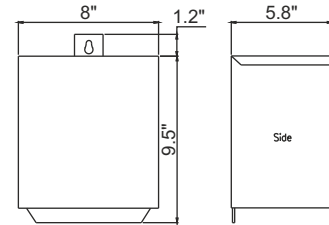
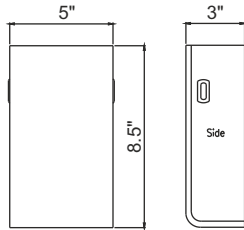

HP	kW	Voltage [V]	Capacitor Type	Carton Box Size			Bottom Knockouts Quantity	Side Knockouts Diameter	Volume
				L	W	H			
0.5	0.37	220-230	START & RUN	9.9"	5.5"	3.6"	2	Ø0.86"	39.3" x 32.2" x 54.3"
0.75	0.55	220-230	START & RUN	9.9"	5.5"	3.6"	2	Ø0.86"	39.3" x 32.2" x 54.3"
1.0	0.75	220-230	START & RUN	9.9"	5.5"	3.6"	2	Ø0.86"	39.3" x 32.2" x 54.3"
1.5	1.1	220-230	START & RUN	11.5"	8.5"	6.5"	2	Ø1.3"	40.9" x 34.6" x 55.1"
2.0	1.5	220-230	START & RUN	11.5"	8.5"	6.5"	2	Ø1.3"	40.9" x 34.6" x 55.1"
3.0	2.2	220-230	START & RUN	11.5"	8.5"	6.5"	2	Ø1.3"	40.9" x 34.6" x 55.1"
5.0	3.7	220-230	START & RUN	11.5"	8.5"	6.5"	2	Ø1.3"	40.9" x 34.6" x 55.1"



Northam Inc.

995/C Griffin Pond Road, Clarks Summit, PA 18411, USA
Phone : +1-570-659-7200, Email : sales@northam-inc.com